



Electro Optical Components, Inc.

5464 Skylane Boulevard, Suite D, Santa Rosa, CA 95403

Toll Free: 855-EOC-6300

www.eoc-inc.com | info@eoc-inc.com



Mid-Infrared (MIR) Photodiode

1.1 - 2.46 μm

Lms24PD-10 series

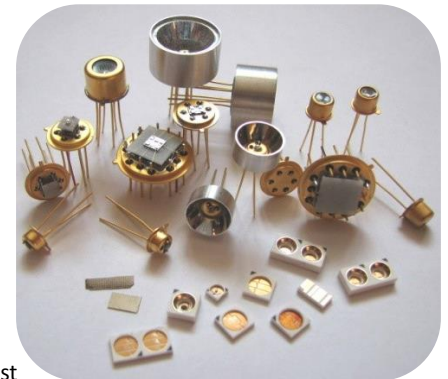

Device parameters	Symbol	Value	Units
Sensitive area diameter	d	1,0	mm
Storage temperature	T _{stg}	-50..+80*	°C
Operating temperature	T _{opr}	-50..+60*	°C
Reverse voltage	V _r	1	V

*PD design for higher storage/operating temperature is available under request

Photodiode parameters	Conditions	Symbol	Value	Units
Cut-off wavelength	T = 25 °C	λ_{cut}	2.40-2.46	μm
Max. sensitivity range (>80%)	T = 25 °C	λ_p	1.4-2.2	μm
Dark current	T = 25 °C; V _r = 1 V	I _d	100-300	μA
Shunt resistance	T = 25 °C; V _r = 10 mV	R _{sh}	1-3	k Ω
Capacitance	T = 25 °C; $\lambda = \lambda_p$	C	1000-1500	pF
Sensitivity	T = 25 °C; $\lambda = \lambda_p$	S	0.8-0.9	A/W
Noise equivalent power	T = 25 °C; $\lambda = \lambda_p$	NEP	(2.5-5.0)*10 ⁻¹²	W/Hz ^{1/2}
Detectivity	T = 25 °C; $\lambda = \lambda_p$	D*	(2.0-3.5)*10 ¹⁰	cm ² Hz ^{1/2} W ⁻¹

Photodiodes Lms24PD-10 series are fabricated from narrow band-gap GaInAsSb/AlGaAsSb-based heterostructures lattice matched to GaSb substrate.

All specifications are for photodiode operation at 25°C unless otherwise stated

Typical spectral response

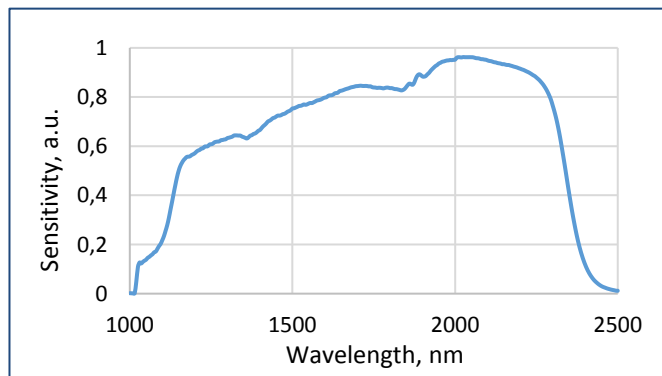

Temperature shift of spectral response

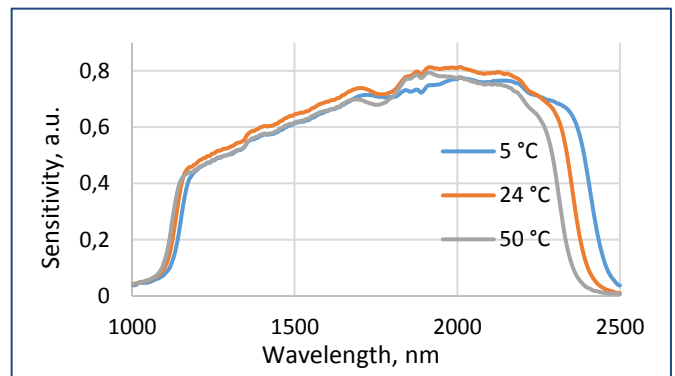

Typical current-voltage characteristic

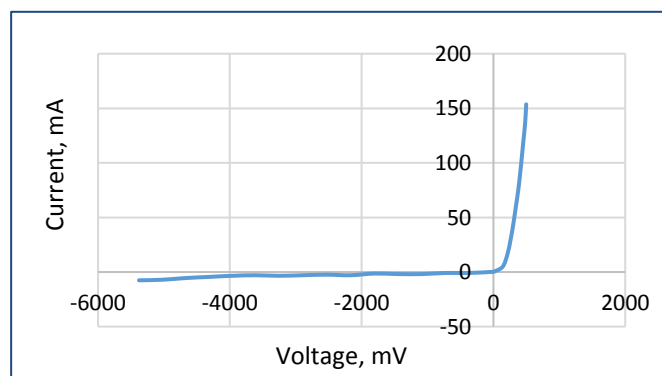

Packages	Model
TO-18 with a cap without a glass window	Lms MIR PD-10
TO-18 with a parabolic reflector without a window	Lms MIR PD-10-R
TO-18 with a parabolic reflector with a glass window	Lms MIR PD-10-RW
TO-5 with a built-in thermocooler and thermoresistor, covered by a cap with a glass window	Lms MIR PD-10-TEM
TO-5 with a built-in thermocooler and thermoresistor, covered by a parabolic reflector with a glass window	Lms MIR PD-10-TEM-R
PD with a built-in preamplifier; TO-18 with a parabolic reflector without a window in an aluminium tube	Lms MIR PD-10-R-PA
PD with a built-in preamplifier; TO-18 with a parabolic reflector with a window in an aluminium tube	Lms MIR PD-10-RW-PA

Recommended modes of PD operation

PD used as a current source (photovoltaic mode)

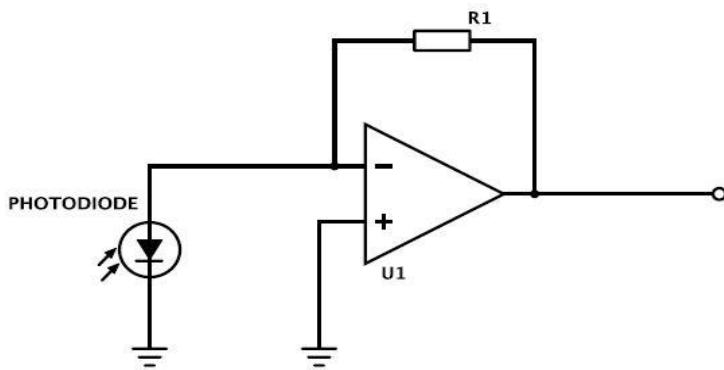

PD used in a photoconductive mode (under reverse bias)

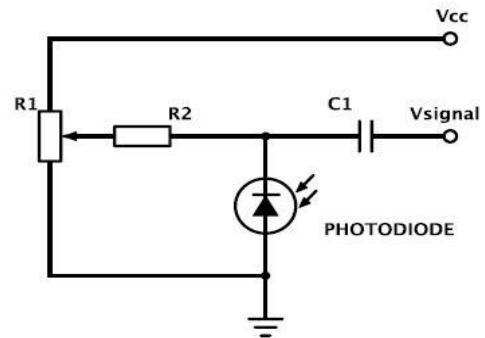

We recommend using **photovoltaic mode**, when PD is used under no reverse bias.
Use photoconductive mode (mode with reverse bias) with caution.

IMPORTANT CAUTIONS:

- please check your connection circuit before turning on the PD;
- please mind the PD polarity: PD anode is marked with a RED dot;
- please do not connect the PD to the multimeter.

Technical Drawings

Lms24PD-10

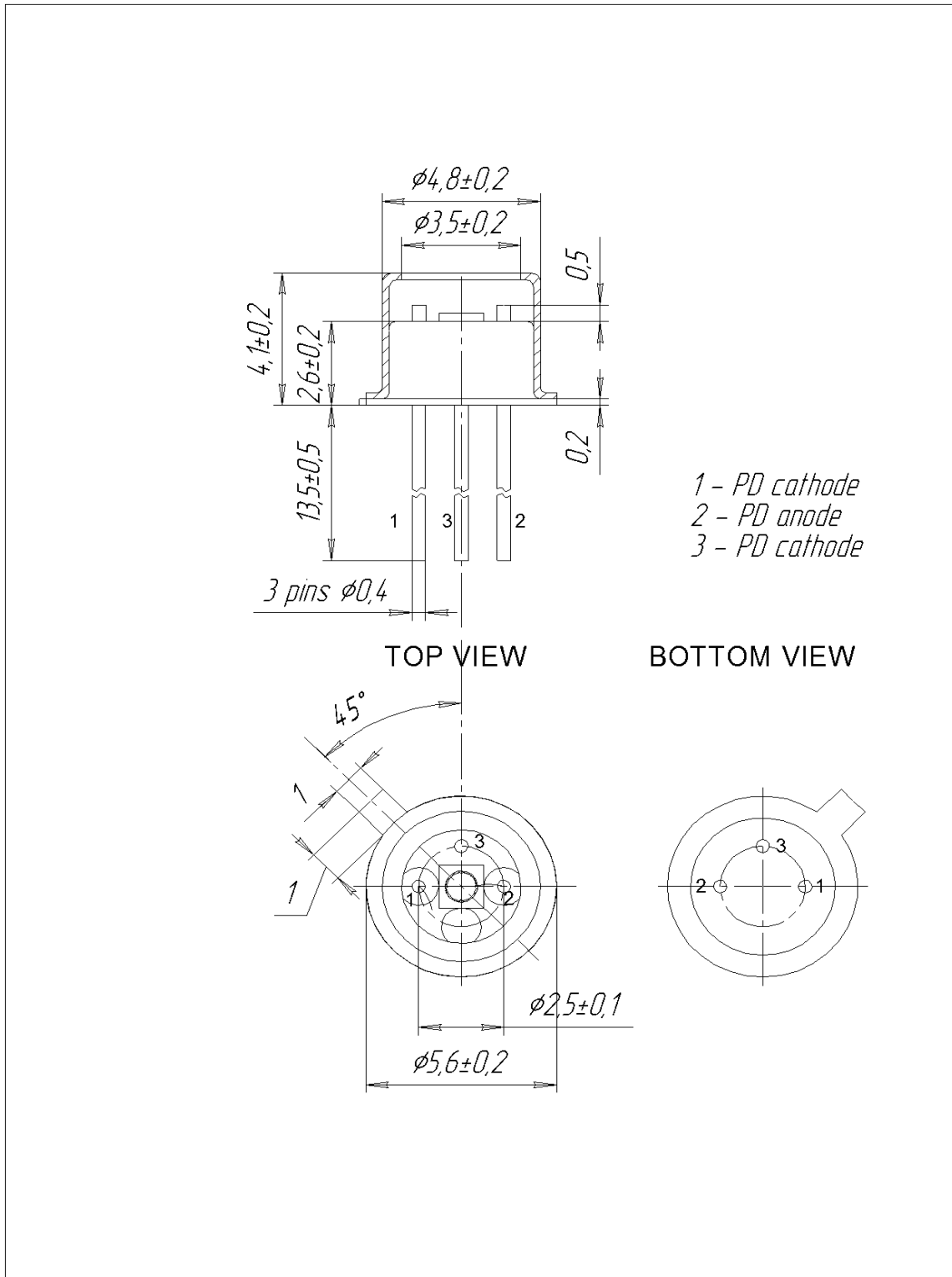

Technical Drawings

Lms24PD-10-R

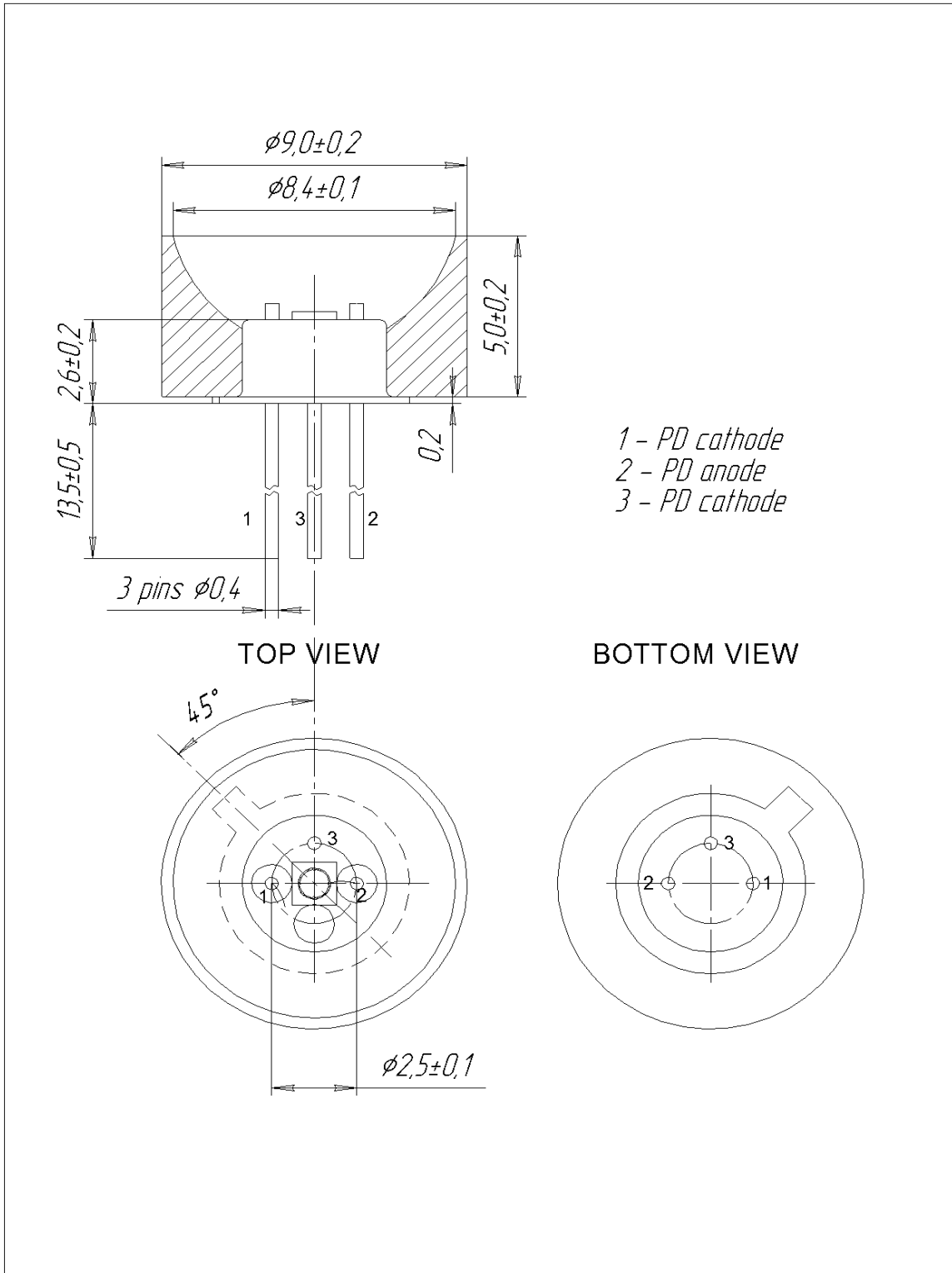

Technical Drawings

Lms24PD-10-RW

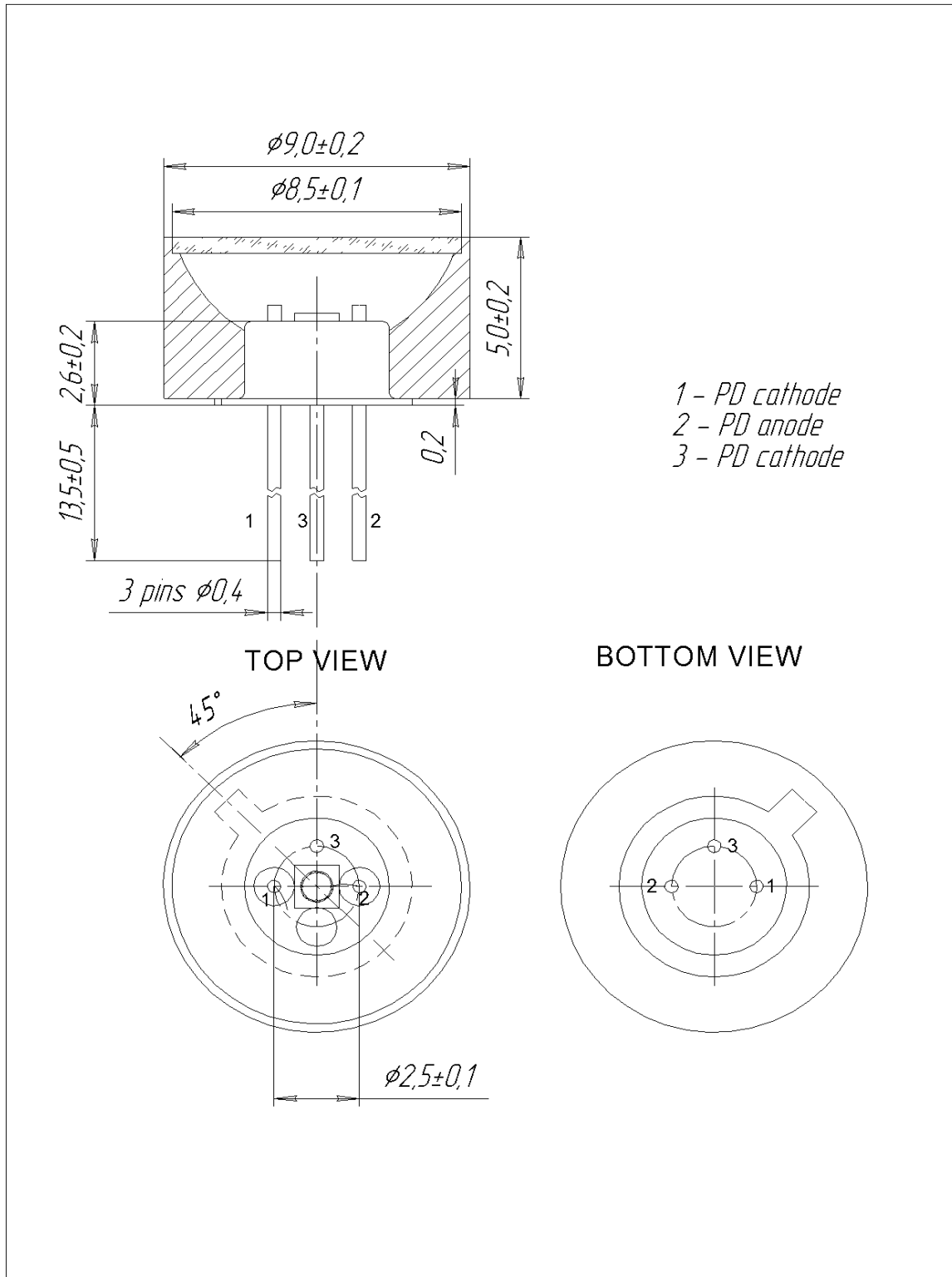

Technical Drawings

Lms24PD-10-TEM

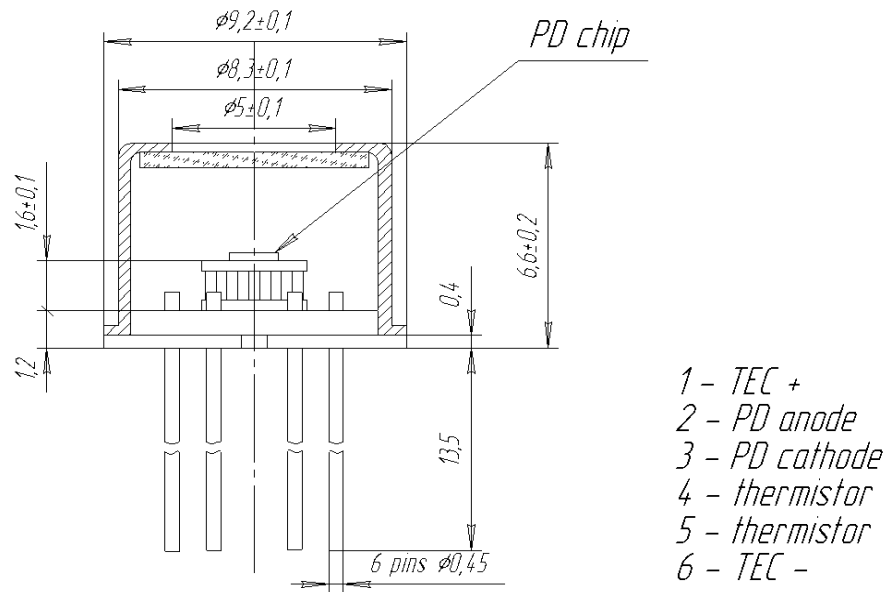

- 1 - TEC +
- 2 - PD anode
- 3 - PD cathode
- 4 - thermistor
- 5 - thermistor
- 6 - TEC -

TOP VIEW

BOTTOM VIEW

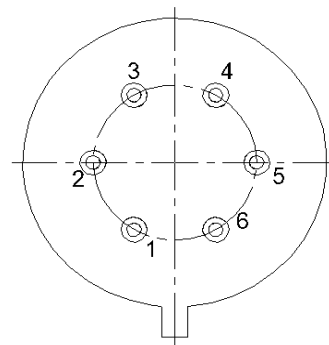
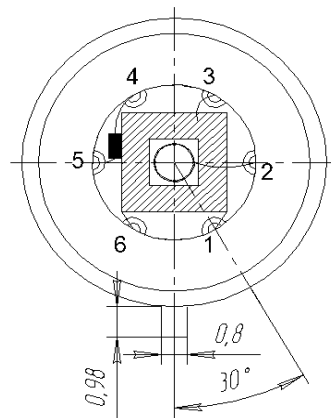

Technical Drawings

Lms24PD-10-TEM-R

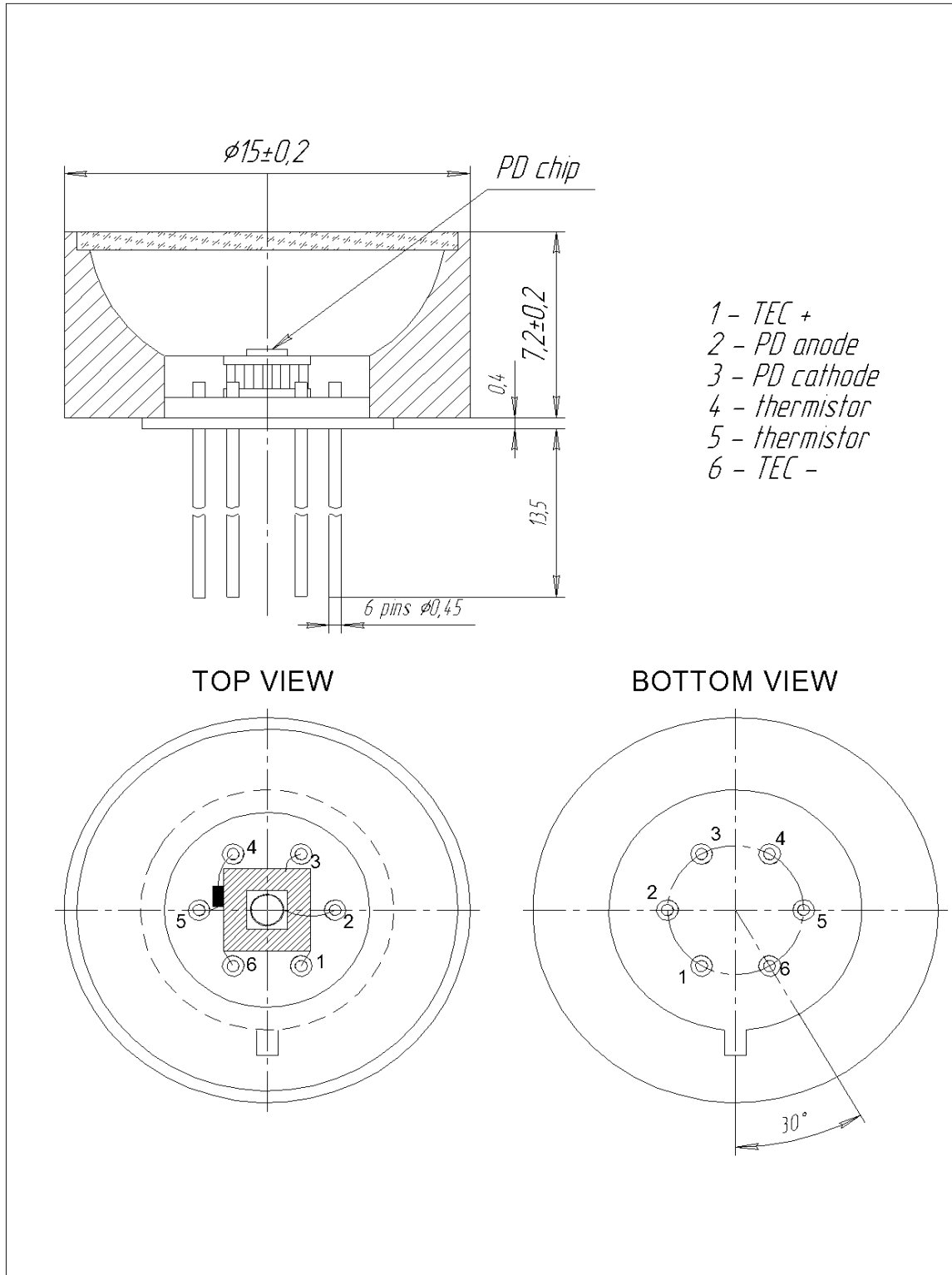

Technical Drawings

Lms24PD-10-R-PA

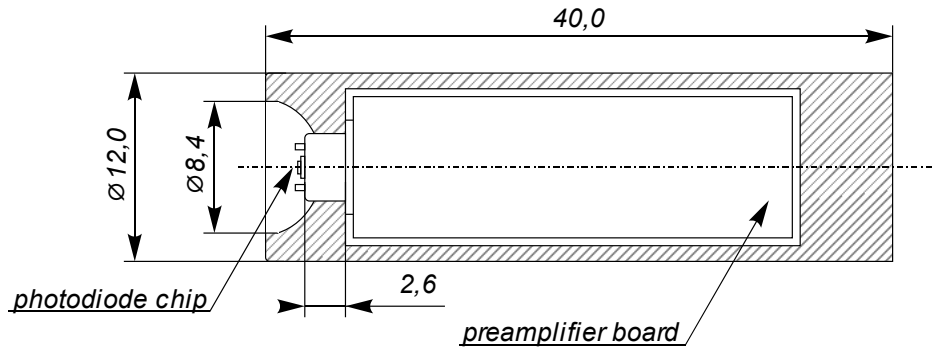

Lms24PD-10-RW-PA

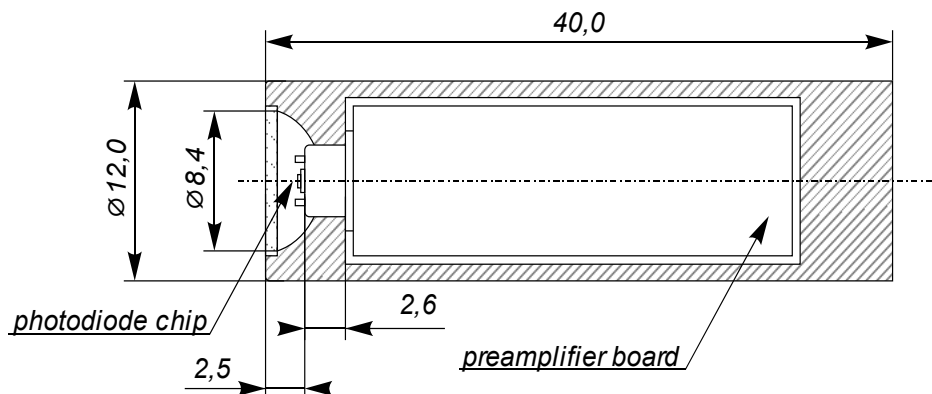

Connections:

The output of PD with a built-in preamplifier has four wires:

- "+" power input (to the "+" of the power output terminal block of the SDM synchronous detector);
- "-" power input (to the "-" of the power output terminal block of the SDM synchronous detector);
- output photodiode signal (to the "-" of the signal input terminal block of the SDM synchronous detector);
- output photodiode signal (to the "+" of the signal input terminal block of the SDM synchronous detector).

For the proper connection mind colours of the wires pointed in the technical data provided with the photodiode.

Related products:

- **LEDs** - sources of mid-infrared radiation;
- **SDM** - synchronous detector for PD models with preamplifiers - Lms MIR PD-XX-R-PA and Lms MIR PD-XX-RW-PA. SDM synchronous detector measures the voltage signal from the output of photodiode preamplifier and converts it to the DC voltage signal proportional to amplitude of voltage from input.
- **TCM** - thermocontroller for PD models with built-in thermoelectric modules (thermocooler and thermistor) - Lms MIR PD-XX-TEM and Lms MIR PD-XX-TEM-R models. TCM enables control and adjustment of PD temperature.