



## Infrared Radiation Source JSIR350-5-BL-C-D2.55-0-0

Very fast radiation source for use with thermopiles and pyroelectric detectors in NDIR gas analysis and other applications.



### Pin Assignment

Bottom View

Pin 1 Power

Pin 2 Case

Pin 3 Power

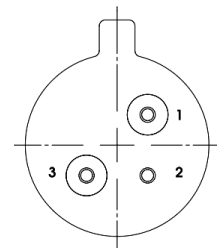

Absolute Max. Ratings		
Power	0.3	W
Housing temperature	200	°C
Active Area Temperature	800	°C

Spectral Output Range <sup>1</sup>	typ. 1 ... 15	μm
Active Area	0.65 x 0.65	mm <sup>2</sup>
Hot Resistant	40±20	Ω
Temperature Coefficient	typ. 650	ppm/K
Time Constant	typ. 7	ms
Nominal Power Consumption	0.175	W
Operation Voltage <sup>2</sup>	typ. 2.8	V
Operation Current <sup>2</sup>	typ. 63	mA
Active Area Temperature <sup>3,5</sup>	640	°C
Window	-	
Mass	~1	g
Housing	T046 (modified)	
Lifetime <sup>4</sup>	> 5,000 h at 740°C > 100,000 h at 640°C	

<sup>1</sup> without window

<sup>2</sup> with 40Ω

<sup>3</sup> at nominal power (0.2W)

<sup>4</sup> at 10 Hz, 50% duty cycle, preliminary results

<sup>5</sup> at T<sub>amb</sub> = 25°C

# Infrared Radiation Source JSIR350-5-BL-C-D2.55-0-0



**MICRO-HYBRID**

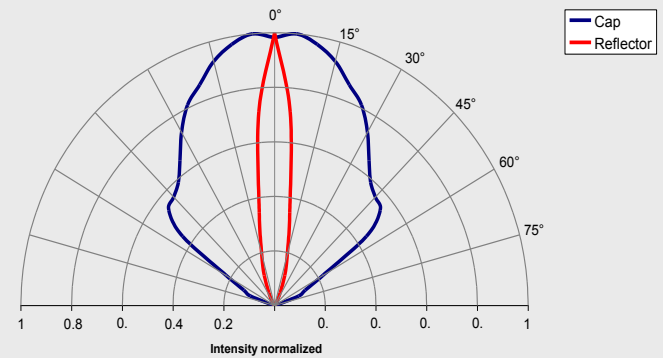
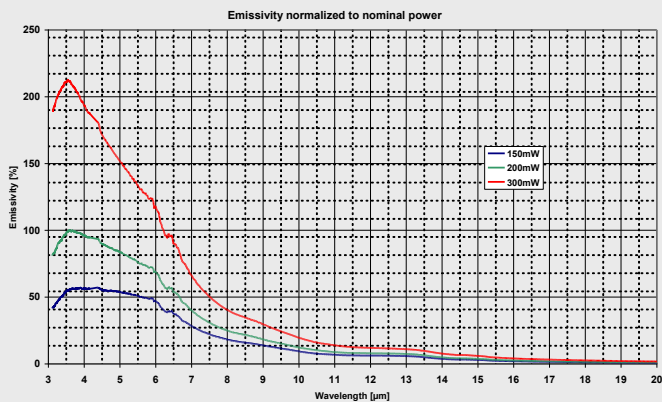
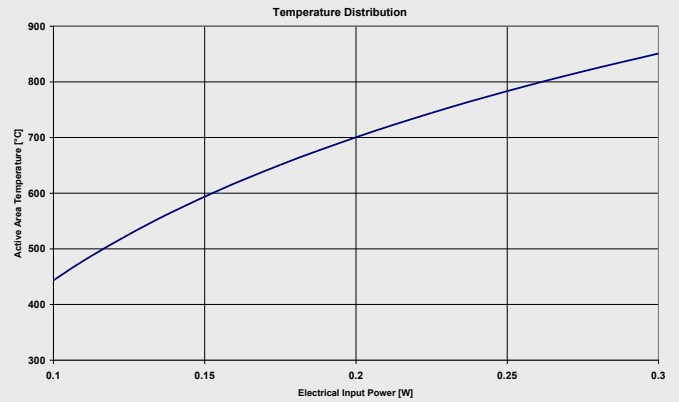
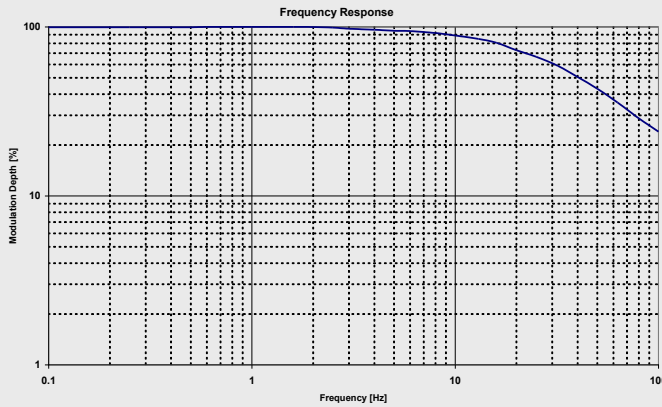

## Housing

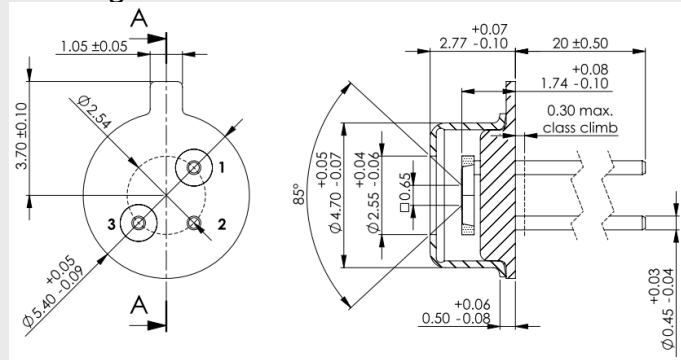

## Operation range

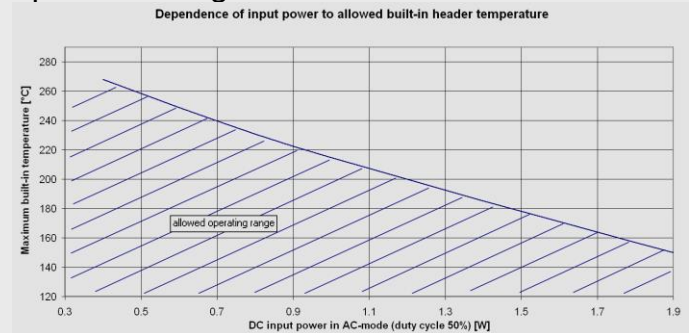

## Optional parts

Window – For hermetic sealing and / or spectral narrowing of the radiation

Evaluation Kit – For independent evaluation of emitters and detectors