



Infrared Radiation Source JSIR350-5-BL-R-D3.6-0-0

Very fast radiation source for use with thermopiles and pyroelectric detectors in NDIR gas analysis and other applications.



Pin Assignment

Bottom View

- Pin 1 Power
- Pin 2 Case
- Pin 3 Power

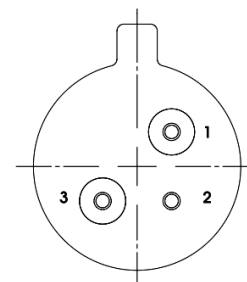

Absolute Max. Ratings		
Power	0.3	W
Housing temperature	200	°C
Active Area Temperature	850	°C

Spectral Output Range ¹	typ. 1 ... 15	μm
Active Area	0.65 x 0.65	mm ²
Hot Resistant	40±20	Ω
Temperature Coefficient	typ. 650	ppm/K
Time Constant	typ. 7	ms
Nominal Power Consumption	0.175	W
Operation Voltage ²	typ. 2.8	V
Operation Current ²	typ. 63	mA
Active Area Temperature ^{3,5}	640	°C
Window	-	
Mass	~1	g
Housing	T046 (modified)	
Lifetime ⁴	> 5,000 h at 740 °C > 100,000 h at 640 °C	

¹ without window

² with 40Ω

³ at nominal power (0.2W)

⁴ at 10 Hz, 50% duty cycle, preliminary results

⁵ at T_{amb} = 25°C

Infrared Radiation Source JSIR350-5-BL-R-D3.6-0-0

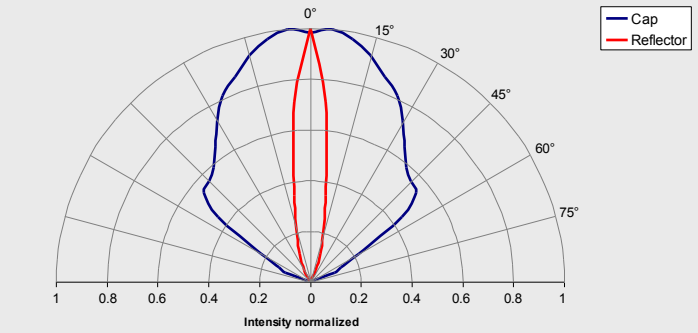
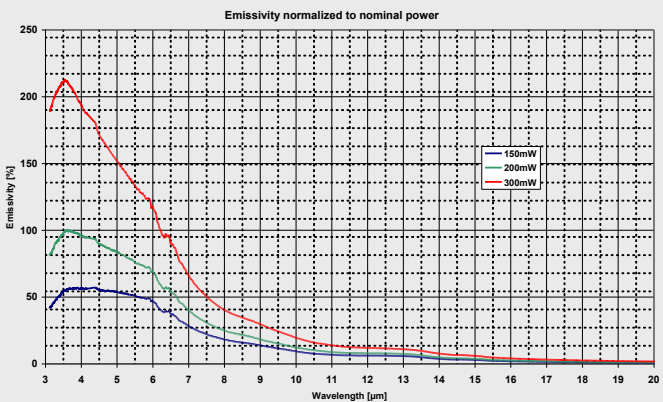
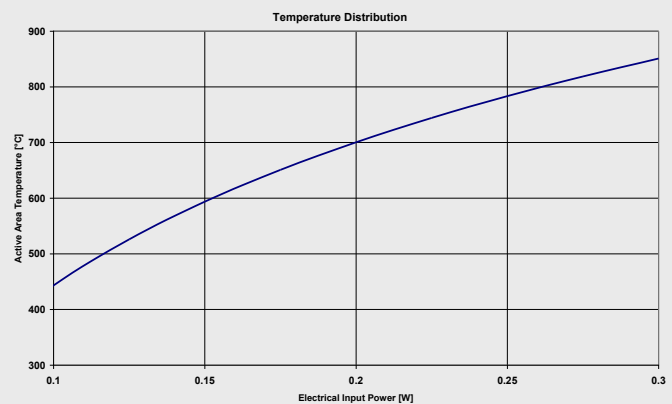
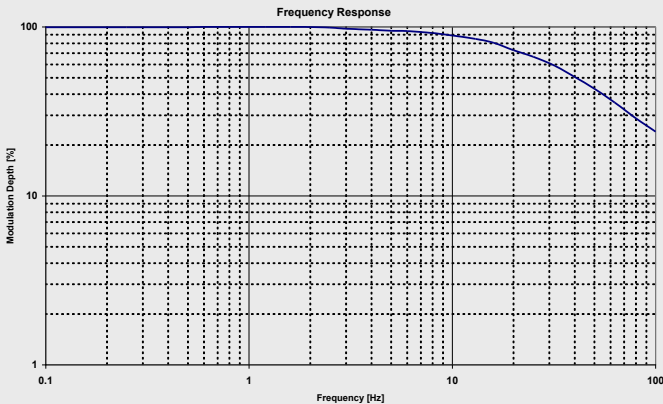

Housing

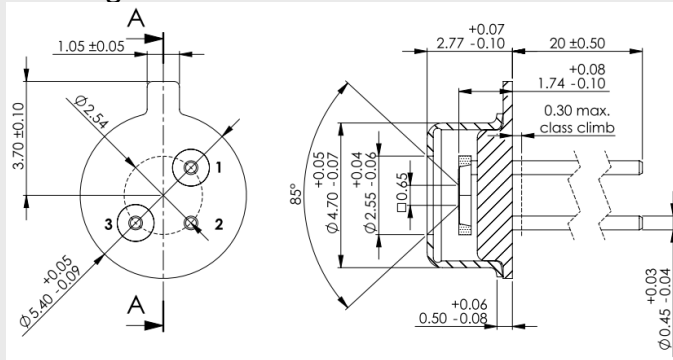

Operation range

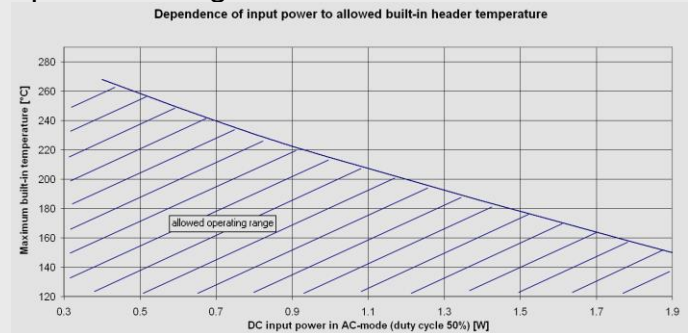

Optional parts

Window – For hermetic sealing and / or spectral narrowing of the radiation

Evaluation Kit – For independent evaluation of emitters and detectors