



## Infrared Spiral Wound Radiation Source JSIR450-R

Powerful radiation source with circular homogeneous temperature distribution for use with thermopiles and pyroelectric detectors in NDIR gas analysis and other applications.

Spectral Output Range <sup>1</sup>	typ. 0.8 ... 15	μm
Active Area	2.2 dia	mm <sup>2</sup>
Hot Resistant	12±1	Ω
Time Constant	typ. 530	ms
Nominal Power Consumption	0.7	W
Operation Voltage <sup>2</sup>	typ. 2.9	V
Operation Current <sup>2</sup>	typ. 242	mA
Active Area Temperature <sup>3,4</sup>	650	°C
Filling Gas	-	
Filter	-	
Mass	~2	g
Housing	T039 (modified)	
Lifetime	> 50,000 h at 650°C	

<sup>1</sup> without window

<sup>2</sup> with 12Ω

<sup>3</sup> at nominal power (0.7W)

<sup>4</sup> at T<sub>amb</sub> = 25°C

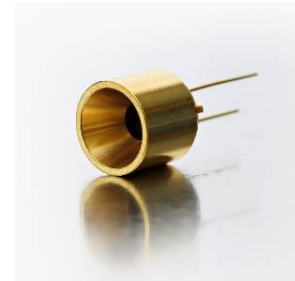

### Pin Assignment

Bottom View

Pin 1 Power

Pin 2 Power

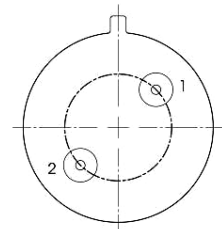

### Absolute Max. Ratings

Power 1.7 W

Housing temperature 200 °C

### Ordering Information

JSIR450-R

6350.11-3.01

# Infrared Spiral Wound Radiation Source JSIR450-R

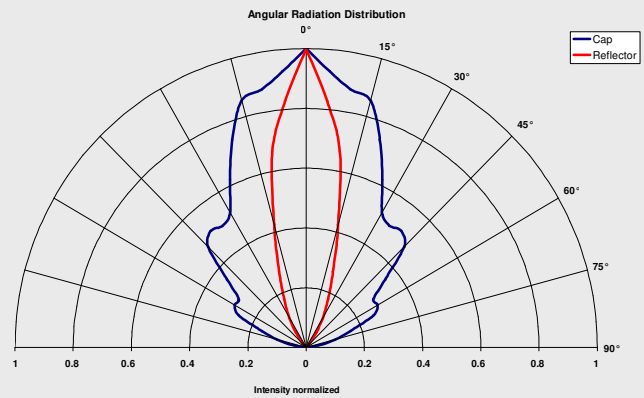
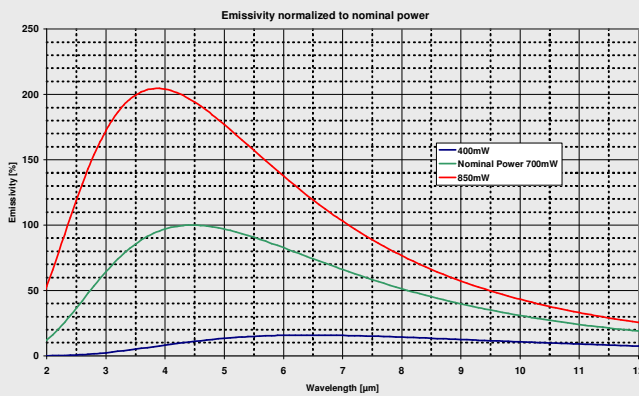
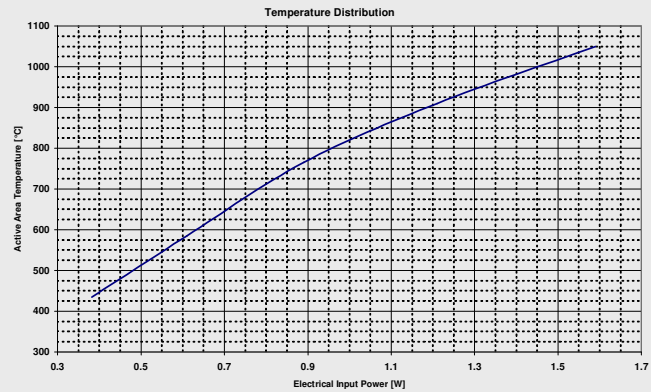
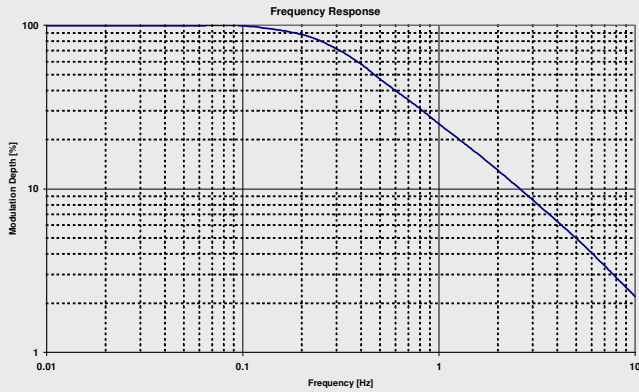

## Housing

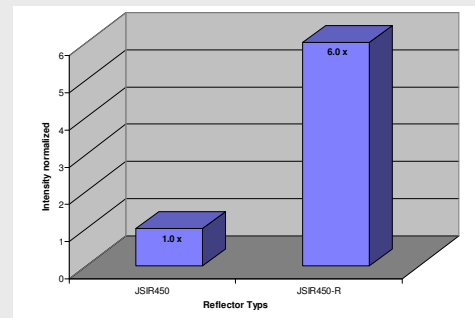
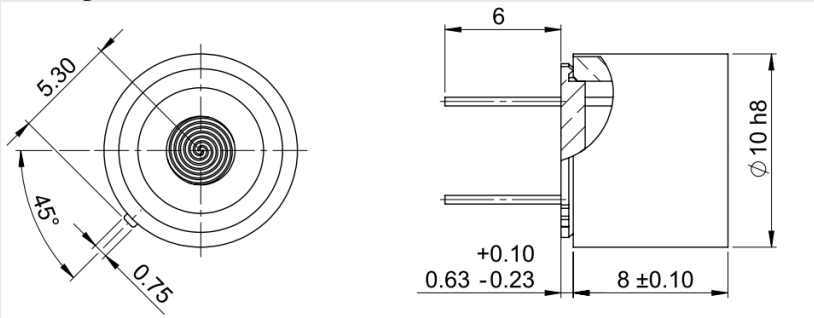

## Optional parts

IR-Detector PS2x4V1- Pyroelectric dual-channel voltage mode detector CO<sub>2</sub>/Ref  
Art.-Nr. 4594.56-H.02

Evaluation Kit - For independent evaluation of emitters and detectors  
Art.-Nr. 7206.01-A.00