



## Powerful Combination for NDIR Gas Analysis - Fast IR Source and Pyroelectric Detector



The IR-Source JSIR 350 in combination with the multichannel pyroelectric detector PSXx1C1 offers best performance like fast testing times due to the excellent advantages of both components.

### Pyroelectric Detector PSXx1C1

- High Sensitivity
- Low Thermal Time Constant
- Low Microphone Effect
- Low Noise Voltage

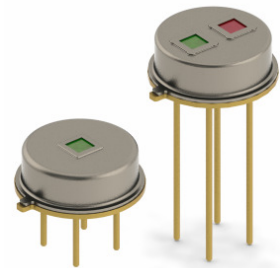

### NDIR Gas Analysis

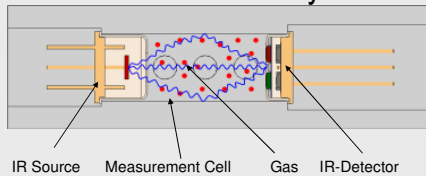

### IR-source JSIR 350

- Fast electrical modulation (no mechanical chopping needed)
- High modulation depth
- Black body radiation (2-14  $\mu\text{m}$ )
- High electrical input to optical output
- Long lifetime
- Robust design (TO39 package)

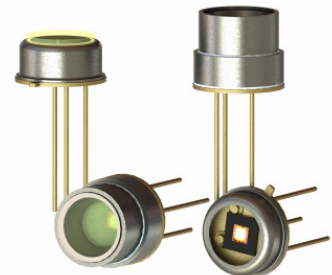
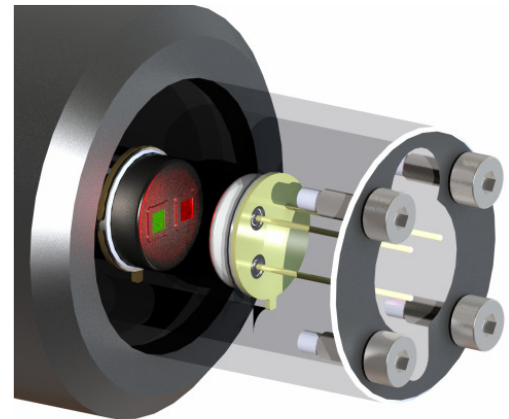
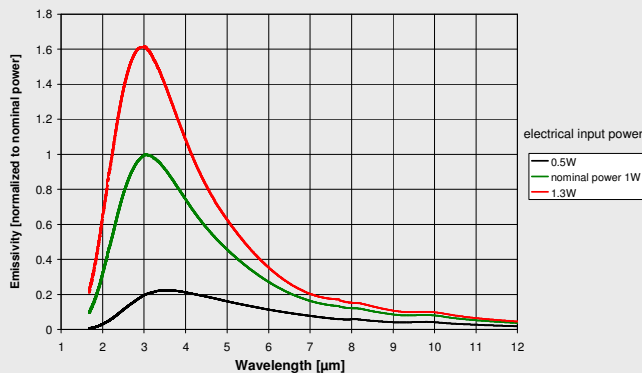

# Powerful Combination for NDIR Gas Analysis - Fast IR Source and Pyroelectric Detector

Frequency Response  
System IR-source JSIR350 and Pyro Detector PSXx1C1

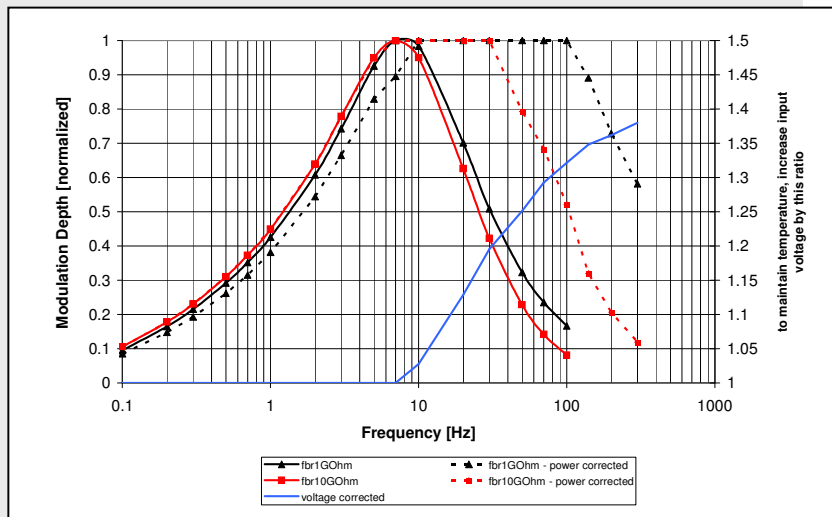

## Ordering Information:

**Pyroelectric Dual Channel Current Mode Detector**  
PS2x1C1-A-S1.5-Filling Gas (GG)-Filters (H/H)  
f.e. PS2x1C1-A-S1.5-N2-E1/D1

**Pyroelectric Single Channel Current Mode Detector**  
PS1x1C1-A-S1.5-Filling Gas (GG)-Filter (H)  
f.e. PS1x1C1-A-S1.5-N2-E1

**Infrared Source JSIR350**  
6351.01-3.01

Housing  
TO39 package

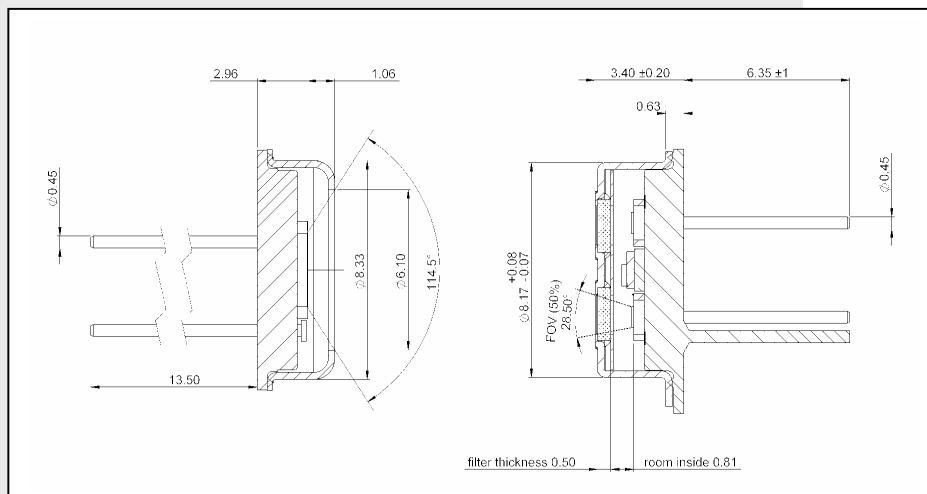

For more detailed technical specifications please see appropriate datasheets