



Electro Optical Components, Inc.

5460 Skylane Boulevard, Santa Rosa, CA 95403

Toll Free: 855-EOC-6300

www.eoc-inc.com | info@eoc-inc.com



Sockets



RoHS Compliant
ISO 9001
Certified

MICRO-HYBRID ELECTRONIC GmbH						
Micro Hybrid Electronic GmbH Model Number	Andon Part Number Replace "XXX" with Terminal Type	Terminal Type		Pin Ø [in]	Figure Number	Page Number
		Thru-Hole	Surface Mount			
JSIR350-22	R200-0403-02T-XXX-R27-L14	01S	93S	.018	3	2
JSIR350-22-R	R200-0403-02T-XXX-R27-L14	01S	93S	.018	3	2
JSIR350-22-SMD	687-28-SM-G10-L14-X	-	-	-	10	3
JSIR350-4-AL-C-D5.8-0-0	R200-0403-04T-XXX-R27-L14	01S	93S	.018	5	2
JSIR350-4-AL-R-D6.0-0-0	R200-0403-04T-XXX-R27-L14	01S	93S	.018	5	2
JSIR350-4-AL-R-D6.0-2-A1-I	R200-0403-04T-XXX-R27-L14	01S	93S	.018	5	2
JSIR350-5-AL-C-D2.55-0-0	R100-0403-02T-XXX-R27-L14	75S	265S	.018	1	1
JSIR450	R200-0402-01T-XXX-R27-L14	01S	93S	.018	2	1
JSIR440-R	R200-0402-01T-XXX-R27-L14	01S	93S	.018	2	1
PS1x1C2-A-S1.5	R200-0404-01T-XXX-R27-L14	01S	93S	.018	6	2
PS1x1C8-A-S1.5	R200-0404-01T-XXX-R27-L14	01S	93S	.018	6	2
PS1x1U2-A-S1.5	R200-0403-02T-XXX-R27-L14	01S	93S	.018	3	2
PS1x1U8-A-S1.5	R200-0403-02T-XXX-R27-L14	01S	93S	.018	3	2
PS1x3C2-A-D3.7	R200-0404-01T-XXX-R27-L14	01S	93S	.018	6	2
PS1x3C10-A-D3.7	R200-0404-01T-XXX-R27-L14	01S	93S	.018	6	2
PS1x3U2-A-D3.7	R200-0403-02T-XXX-R27-L14	01S	93S	.018	3	2
PS1x3U10-A-D3.7	R200-0403-02T-XXX-R27-L14	01S	93S	.018	3	2
PS1x4V1-A-S1.5	R200-0403-02T-XXX-R27-L14	01S	93S	.018	3	2
PS2x1C2-A-S1.5	R200-0805-01T-XXX-R27-L14	75S	265S	.018	7	2
PS2x1C8-A-S1.5	R200-0805-01T-XXX-R27-L14	75S	265S	.018	7	2
PS2x1U2-A-S1.5	R200-0404-01T-XXX-R27-L14	01S	93S	.018	6	2
PS2x1U8-A-S1.5	R200-0404-01T-XXX-R27-L14	01S	93S	.018	6	2
PS2x4V1-A-S1.5	R200-0404-01T-XXX-R27-L14	01S	93S	.018	6	2
PS4x2C1-A-S1.4	R200-0808-01T-XXX-R27-L14	75S	265S	.018	9	2
TS1x80B-A-D0.48	R200-0404-01T-XXX-R27-L14	01S	93S	.018	6	2
TS1x80B-A-D0.75-	R200-0403-03T-XXX-R27-L14	01S	93S	.018	4	2
TS1x80B-A-D0.75-...-180	R200-0403-03T-XXX-R27-L14	01S	93S	.018	4	2
TS1x200B-A-D3.55	R200-0403-04T-XXX-R27-L14	01S	93S	.018	5	2
TS1x200B-B-D2.4	R100-0403-02T-XXX-R27-L14	75S	265S	.018	1	1
TS2x200B-A-S1.5	R200-0404-01T-XXX-R27-L14	01S	93S	.018	6	2
TS4x200B-A-S1.5	R230-0806-05T-XXX-R27-L14	211S	384S	.018	8	2
TS4xQ200B-A-S1.5	R230-0806-05T-XXX-R27-L14	211S	384S	.018	8	2
JSIR350-5-BL-C-D2.55-0-0	R100-0403-02T-XXX-R27-L14	75S	265S	.018	1	1
JSIR350-4-CB	687-28-SM-G10-L14-X	-	-	-	10	3
JSIR350-5-CB	687-28-SM-G10-L14-X	-	-	-	10	3
JSIR350-6	687-28-SM-G10-L14-X	-	-	-	10	3

Top View Shown

Units: in [mm]

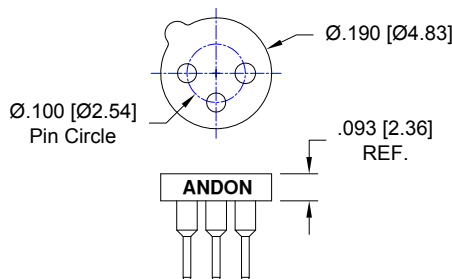

Fig. 01

Thru-Hole: R100-0403-02T-75S-R27-L14

Surface Mount: R100-0403-02T-265S-R27-L14

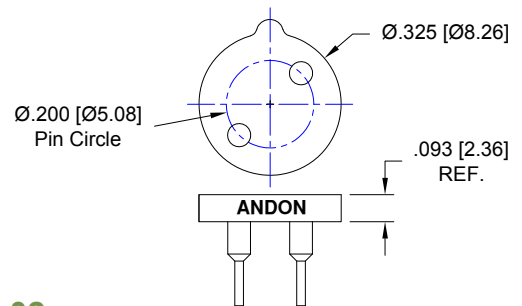

Fig. 02

Thru-Hole: R200-0402-01T-01S-R27-L14

Surface Mount: R200-0402-01T-93S-R27-L14

MICRO-HYBRID ELECTRONIC GmbH Continued

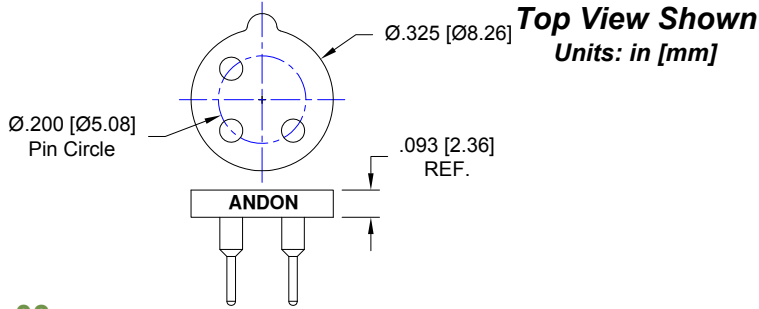

Fig. 03

Thru-Hole: R200-0403-02T-01S-R27-L14
Surface Mount: R200-0403-02T-93S-R27-L14

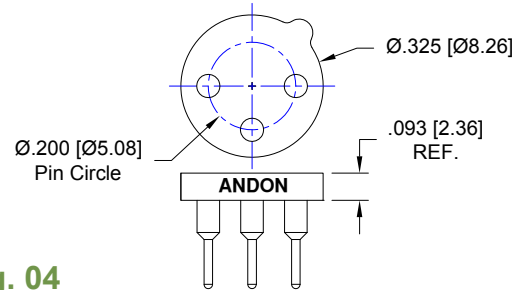

Fig. 04

Thru-Hole: R200-0403-03T-01S-R27-L14
Surface Mount: R200-0403-03T-93S-R27-L14

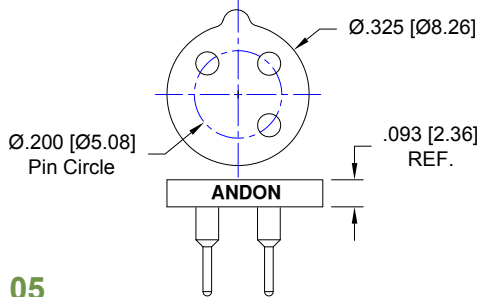

Fig. 05

Thru-Hole: R200-0403-04T-01S-R27-L14
Surface Mount: R200-0403-04T-93S-R27-L14

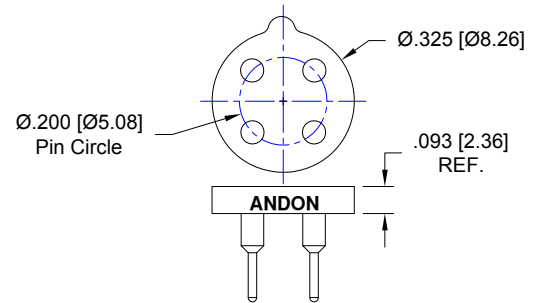

Fig. 06

Thru-Hole: R200-0404-01T-01S-R27-L14
Surface Mount: R200-0404-01T-93S-R27-L14

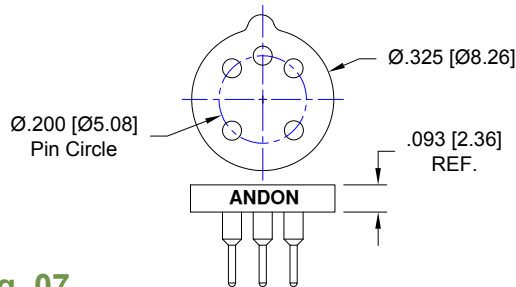

Fig. 07

Thru-Hole: R200-0805-01T-75S-R27-L14
Surface Mount: R200-0805-01T-265S-R27-L14

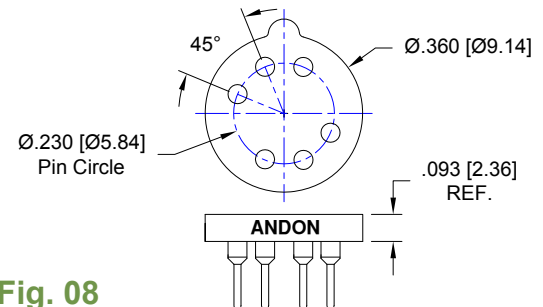

Fig. 08

Thru-Hole: R230-0806-05T-211S-R27-L14
Surface Mount: R230-0806-05T-384S-R27-L14

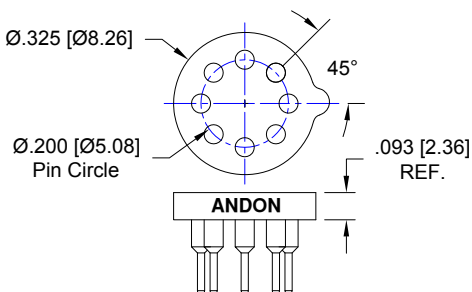

Fig. 9

Thru-Hole: R200-0808-01T-75S-R27-L14
Surface Mount: R200-0808-01T-265S-R27-L14

MICRO-HYBRID ELECTRONIC GmbH Continued

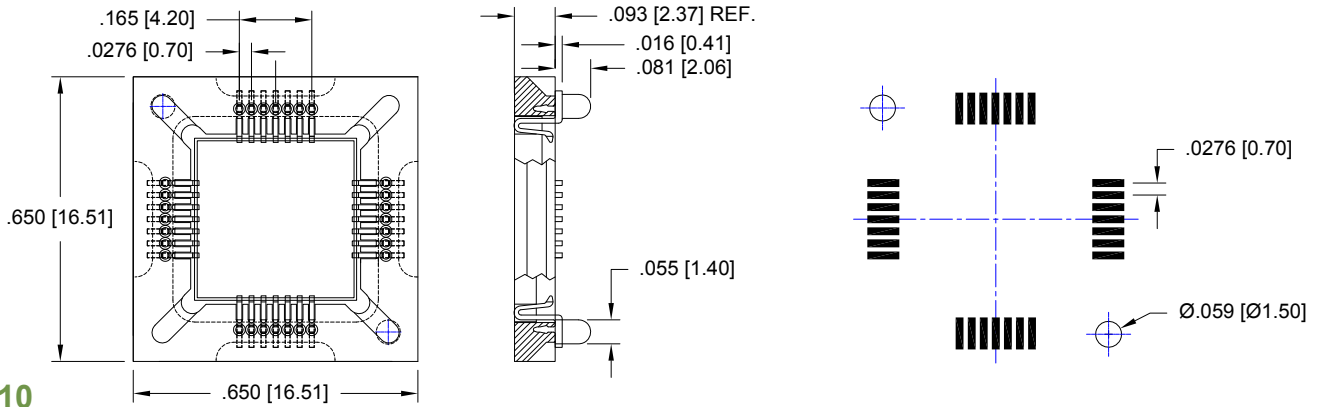
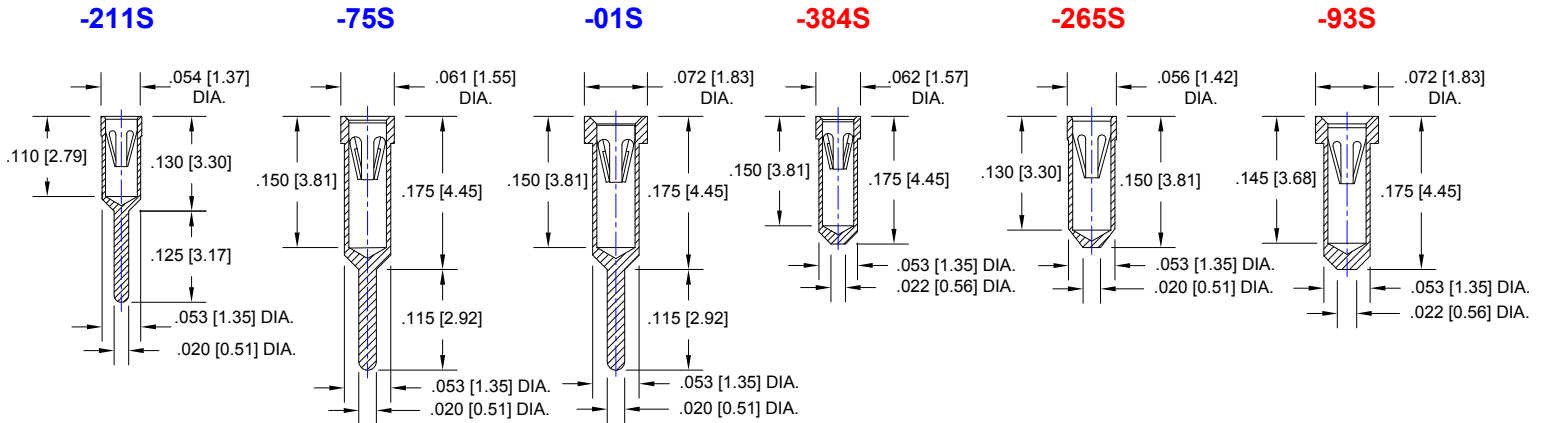

Fig. 10

Surface Mount: 687-28-SM-G10-L14-X

Replace "-X" with "-1" for index pins or "-0" for none

Socket Terminal Details
Cross Section View Shown Units: in [mm]



Technical Information

Material:

Insulator: Hi-Temp UL 94V-O
Terminal: Brass, per ASTM-B16
Contact: BeCu, Per ASTM-B194

Plating: RoHS COMPLIANT

R27 TERMINAL: GOLD / CONTACT: GOLD

R17 TERMINAL: TIN / CONTACT: GOLD

OTHER PLATINGS AVAILABLE

Terminal Acceptance and Forces

Thru Hole Terminals				Surface Mount Terminals			
Thru Hole Terminal	Accepts Pin Diameter	Insertion Force	Withdrawal Force	Surface Mount Terminal	Accepts Pin Diameter	Insertion Force	Withdrawal Force
-211S	Ø.018 [Ø0.46]	9.0 oz Avg.	2.0 oz Min	-384S	Ø.018 [Ø0.46]	9.0 oz Avg.	2.0 oz Min
-75S	Ø.018 [Ø1.46]	9.0 oz Avg.	2.0 oz Min	-265S	Ø.018 [Ø0.46]	9.0 oz Avg.	2.0 oz Min
-01S	Ø.018 [Ø0.46]	9.0 oz Avg.	2.0 oz Min	-93S	Ø.018 [Ø0.46]	9.0 oz Avg.	2.0 oz Min

MOUNTING OPTIONS

