

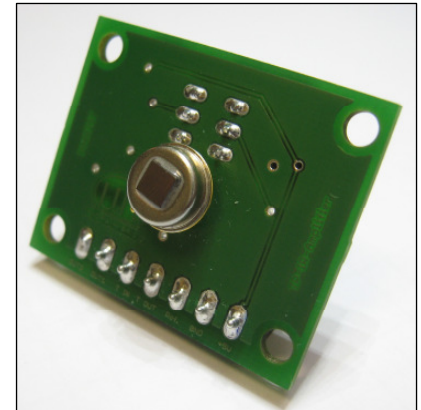

## Product Specification Preamplifier Board TE2AMP1 for Thermopile Detector

Index	Page
General Description .....	1
Operation Parameters .....	2
Dimensions .....	3
Assembly Hints for Thermopile Detectors .....	3
Adjustment of the Amplification Factor .....	4
Circuit Diagram .....	5



### General Description

The preamplifier board (TE2AMP1) for IR-thermopile detectors of the Micro-Hybrid Electronic GmbH could be used for signal processing of the following applications (for example):

- gas analysis
- contactless temperature measurement
- laboratory und test set-ups

The basic version of the preamplifier board could be assembled with the following types of detectors (not included, please order separately, for more information see datasheets under [www.micro-hybrid.de](http://www.micro-hybrid.de)):

Description	Characteristics	Reference Number	
<b>TS200M1</b>	single-channel miniature detector (TO-46 housing) for CO <sub>2</sub> -gas analysis (narrow band filter-4.26 μm)	4591.11-3.01	
<b>TS80T5</b>	single-channel detector (TO-39 housing) with broadband filter for measuring IR-radiation in the range between 8 and 14 μm	4592.67-4.02	
<b>TS2x2001</b>	two-channel detector (TO-39 housing) for high precision determination of gases by using NDIR (CO <sub>2</sub> -filter with 4.265 μm and reference filter with 4.000 μm)	4594.50-2.01	

Table 1: Overview detector types

The preamplifier is arranged with three amplification ranges (300, 1000 and 3000 times), that could be adjusted for every detector channel manually. The pin assignment of the preamplifier is shown in Figure 1 and Table 2. The pins have an additional screw terminal strip (on the backside of the board).

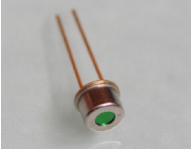
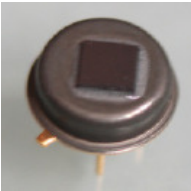
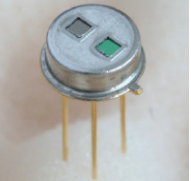
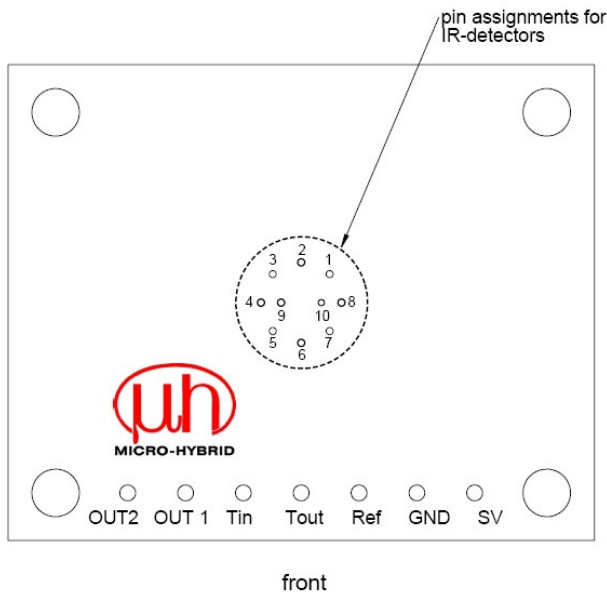

Figure 1:  
Preamplifier board – front view  
(schematic, without detector)

Additionally, the signal of a thermistor for observing the temperature of the detector is led to terminal pins (for models TS80T5 und TS2x2001). The board is operating in an operation voltage range of 1.8-5.5 V, at this the internal reference voltage is 1.2 V. The preamplifier board could be used in a temperature range of -20 to 70 °C (depending on the detector type). More characteristics are shown in Table 2. (for T=20 °C).

**Operation Parameters**

Parameter	Min.	Typ.	Max.	Unit	Comment
Supply Voltage	1.8		5.5	V	
Charging Rate	3.0	4.5	5.0	mA	
Amplification	300		3000		amplification defined by jumper position
Reference Voltage	1.2			V	
Band Width (-3 dB)	DC to 12			Hz	

**Pin Assignment of the Preamplifier Board (see Figure 1Fehler! Verweisquelle konnte nicht gefunden werden.)**

Denomination	Signal
SV (+5V)	Supply Voltage
GND	Reference Potential
Ref	Reference Voltage
Tout	Thermistor Signal (only if available)
Tin	Thermistor Signal (only if available)
OUT1	Detector Signal TP 1
OUT2	Detector Signal TP 2 (only if available)

Table 2: Overview operating parameters and pin assignments

## Dimensions

The dimension of the preamplifier board

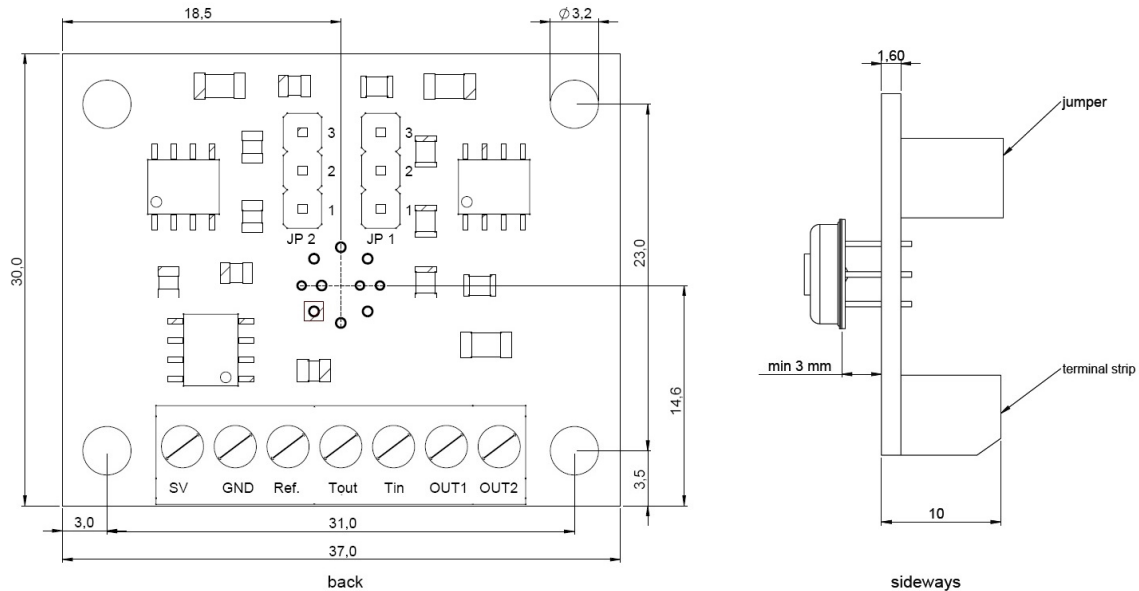

Figure 1: Preamplifier board – back and side view

## Assembly Hints for Thermopile Detectors

One could see the alignment and the pin assignment of the elected detector type in Table 3 (be aware of the “detector nose”, see also Figure 1). The arrangement of assembling the thermopile detector on the TE2AMP1 is shown in Figure 2.

### **Attention:**

The distance between the detector and the preamplifier board has to be at least 3mm to avoid a short circuit between both components.

For assembling the TS200M1-detector on the preamplifier board, remove the ground pin (e.g. with the help of a side cutter, ex socket, see Figure 2), since there is no pin hole on the board.

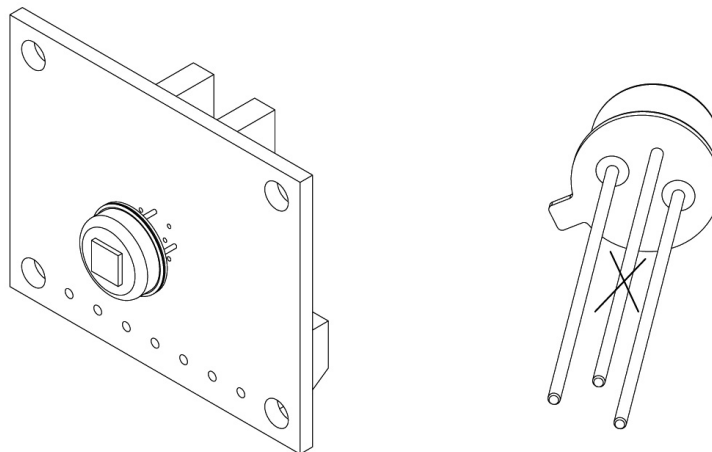

Figure 2: Direction of assembling

Removing the pin - TS200M1

Detector	Internal Detector Pin Assignment	Front View on TE2AMP1	Pin Assignment – Terminal Strip X1 (see diagram circuit, Fehler! Verweisquelle konnte nicht gefunden werden.)
TS200M1			9 - Ref – reference voltage TP 10 - OUT2 – output signal TP
TS80T5			2 - Tout – thermistor signal 4 - Tin – thermistor signal 6 - OUT1 – output signal TP 8 - Ref – reference voltage TP
TS2x2001			1 - OUT 1 – output signal TP 1 3 - OUT 2 – output signal TP 2 5 - Tout – thermistor signal 7 - Ref – reference voltage for thermistor, TP1 and TP2

Table 3: Pin assignment

The effectively voltage signal of the detector is calculated by determining the difference between output signal (be aware of the chosen amplification factor) and the reference voltage (1.2 V).

### Adjustment of the Amplification Factor

The preamplifier is equipped with three amplification ranges that could be adjusted manually on the back side of the board (see Figure 1 and Table 1).

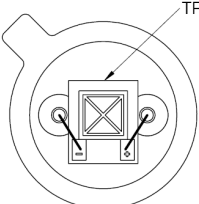
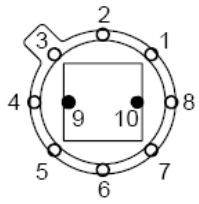
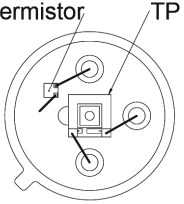
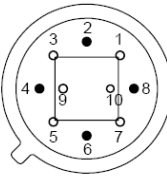
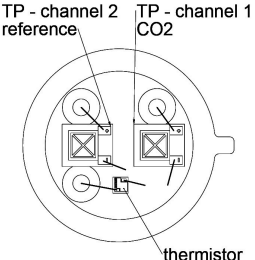
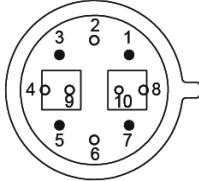

Jumper position	Jumper (JP)– Top View	Amplification Factor
2 & 3		300
1 & 2		1000
unreserved		3000

Table 1: Adjustment of the amplification factor

The amplification factor has to be adjusted in the following jumper row (see Figure 1, depending on the chosen detector type)

Detector	Channel	Jumper Row (JP)
TS200M1	1	JP1
TS80T5	1	JP2
TS2x2001	1	JP2
	2	JP1

Table 2: Detector type and jumper row

For the two channel detector, both channels could be adjusted separately.

### Circuit Diagram

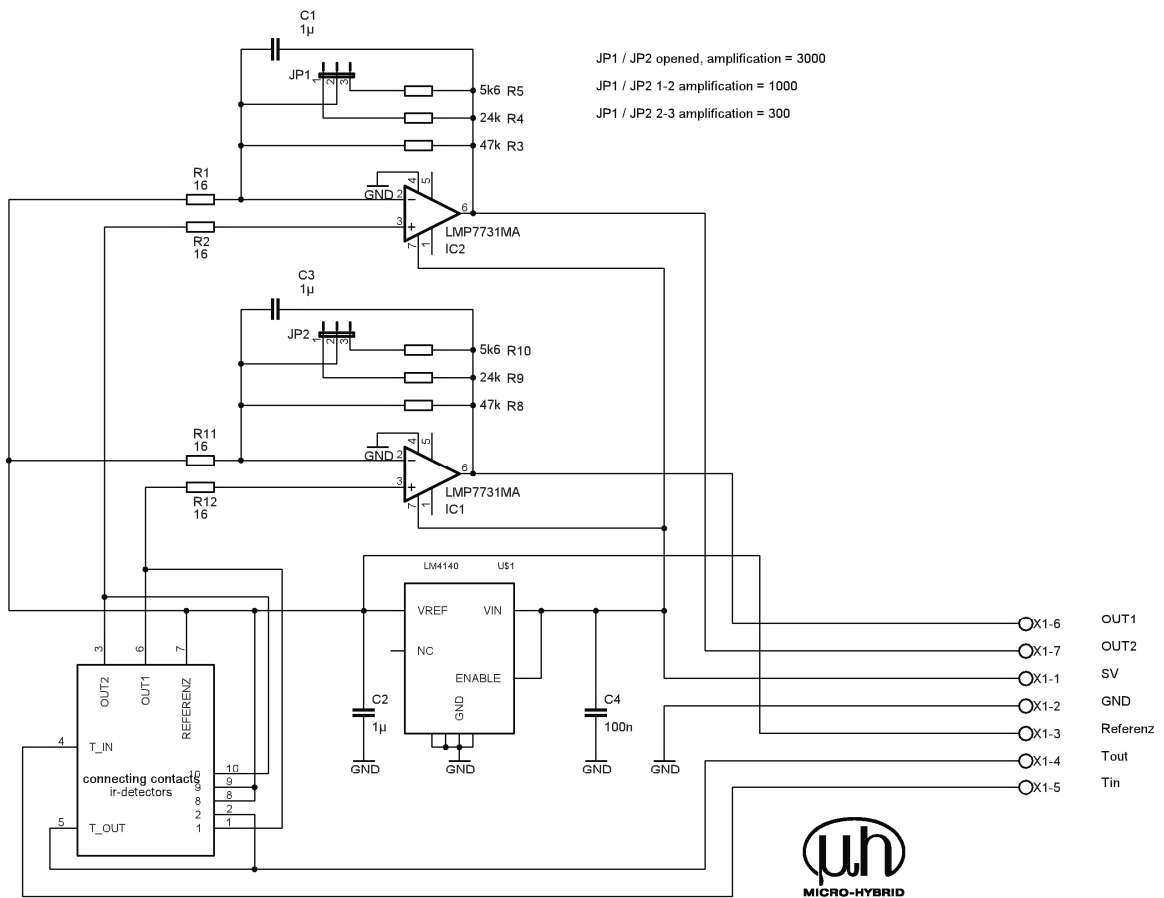

Figure 3: Circuit diagram of the TE2AMP1- board

For more information:  
**ELECTRO OPTICAL COMPONENTS, INC.**  
 5460 Skylane Blvd.,  
 Santa Rosa, CA 95403  
 Tel: 707-568-1642  
 Fax: 707-568-1652  
 Email: info@eoc-inc.com  
 Web: www.eoc-inc.com