

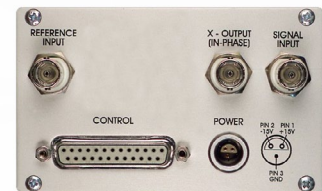

Datasheet

LIA-MV-200-L

Lock-In-Amplifier Module

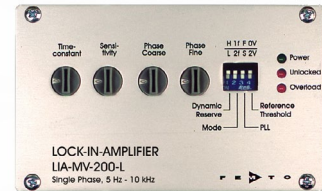

Features

- **BNC Connectors for Input and Output Signals**
- **Rugged Aluminium Housing**
- **Single Phase Detection with X Output**
- **Working Frequency 5 Hz ... 10 kHz, Digital Phase Shifter 0 ... 360°**
- **Parameter Control by local Switches and opto-isolated digital Inputs**
- **Optional Reference Oscillator Module available**

Applications

- **Spectroscopy**
- **Luminescence, Fluorescence, Phosphorescence Measurements**
- **Light Scattering Measurements**
- **Opto-electronical Quality Control**

Block Diagram

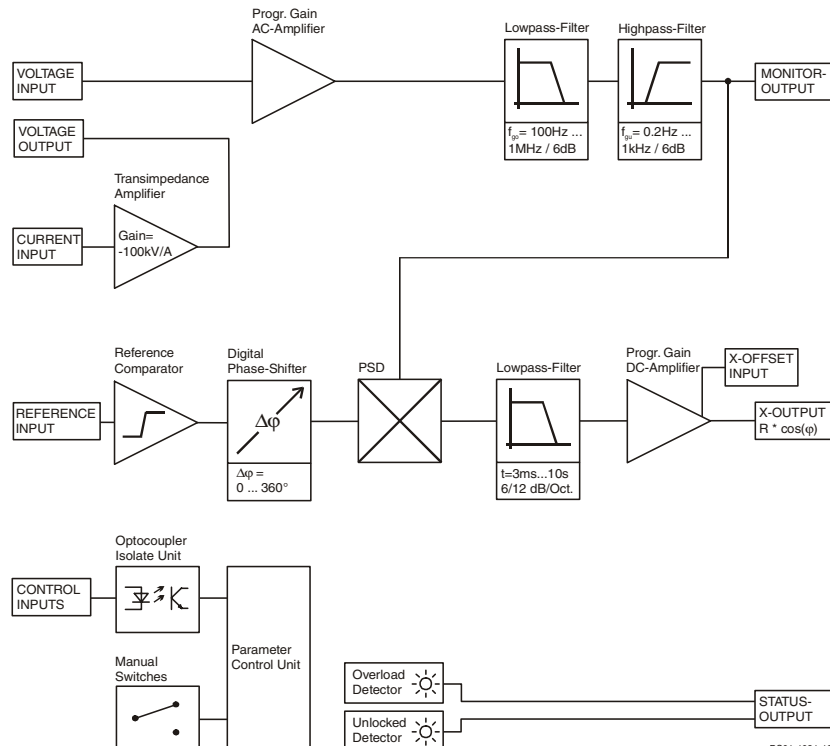

Lock-In-Amplifier Module

Specifications	<i>Test Conditions</i>	<i>V_s = ± 15 V, T_a = 25°C</i>
Voltage Input	Voltage Input Characteristic	True Differential Instrumentation-Amplifier
	Voltage Input Range	3 μV ... 1V in 1-3-10 steps (for Full Scale Output)
	Voltage Input Coupling	AC
	Voltage Input Impedance	1 MΩ // 4 pF
	Voltage Input Noise	12 nV/√Hz
	Voltage Input CMRR	110 dB @ 1 kHz, 100 dB @ 10 kHz
	Voltage Input Gain Drift	100 ppm/K
Current Input	Current Input Characteristic	Transimpedance-Amplifier, -100 kV/A (inverting)
	Current Input Range	30 pA ... 10 μA in 1-3-10 steps (for Full Scale Output)
	Current Input Noise	0.4 pA/√Hz
	Current Input Source- Capacit.	10 pF – 500 pF (recommended)
	Current Input Gain Error vs. Source Capacitance	Cs f < 10 kHz
		10 pF < 1 %
		100 pF < 1 %
	1 nF < 2 %	
Signal Filter (without optional Bandpass-Module)	Signal Filter Lowpass (-3 dB BW)	1 MHz, 100 kHz, 10 kHz, 1 kHz, 100 Hz; 6 dB/Oct. selectable per jumper
	Signal Filter Highpass (-3 dB BW)	0.2 Hz, 1 Hz, 10 Hz, 100 Hz, 1 kHz; 6 dB/Oct. selectable per jumper
	Signal Filter Cutoff accuracy	± 20 %
	Max. Dynamic Reserve	80 dB
Signal Monitor Output	Signal Monitor Output Gain	1 ... 3333 (depends on Gain-Setting)
	Signal Monitor Output Voltage	± 8 V max.
	Signal Monitor Output Impedance	100 Ω
	Signal Monitor Output Current	± 10 mA max.
	Note	When using Current Input with low Input Ranges, the Monitor Output may be disabled by opening the soldering jumper at the Board (near JP1) to prevent from recoupling.
Demodulator	Demodulator Dynamic Reserve	15 dB @ Ultra Stable Setting 35 dB @ Low Drift Setting 55 dB @ High Dynamic Setting
Reference Input	Reference Input Voltage Range	± 100 mV ... ± 5 V @ bip. Mode (0 V Comparator Threshold) - 5 V / +10 V @ TTL Mode (+2 V Comparator Threshold)
	Reference Input Impedance	1 MΩ
	Reference Acquisition Time	max. 2 s @ Fast Setting max. 4 s @ Slow Setting
Phase Shifter	Phase Shifter Type	Digital, Working Frequency 5 Hz ... 10 kHz
	Phase Shifter Range	0 ... + 360 °
	Phase Shifter Resolution	1.4 °
	Phase Shifter Drift	< 100 ppm/K
	Phase Shifter Accuracy	< 0.3 °
Time Constants	Time Constant Range	3 ms ... 10 s in 1-3-10 steps
	Time Const. Filter Characteristic	6 dB/Oct. or 12 dB/Oct. Switchable

Lock-In-Amplifier Module

Specifications (continued)
Output

Output Channels	X = In Phase
Output Voltage Range	± 10 V (@ 2 kΩ Load)
Output Current	± 5 mA max.
Output Impedance	50 Ω
Output DC-Stability	5 ppm/K @ Ultra Stable Setting 50 ppm/K @ Low Drift Setting 500 ppm/K @ High Dynamic Setting
Output Basic Accuracy	2 % @ sinusoidal input signal
Output Voltage Offset Range	± 100 % Full Scale by ± 10 V Control Voltage
Output Voltage Offset Control-	
Output Load Impedance	> 2 kΩ

Status Indicator LED

Functions	Amplifier Overload Status Reference PLL Unlocked Status
-----------	--

Digital Control

Control Input Voltage	Low: - 0.8 V ... + 0.8 V, High: + 1.8 V ... + 12 V
Control Input Current	0 mA @ 0V, 1.5 mA @ + 5 V, 4.5 mA @ + 12V typ.
Digital Status Output Voltage	Active: + 4.5 V typ., Non Active: 0 V typ.
Digital Status Output Current	10 mA max.

Power Supply

Supply Voltage	± 15 Vdc ... ± 18 Vdc
Supply Current	- 60 mA, + 100 mA

Case

Material	Aluminium anodized
Dimension	64,4 x 105,0 x 223,0 mm (without BNC-connectors)
Weight	1000 gr. (2.2 lbs)

Temperature Range

Storage Temperature	- 40 ... + 100 °C
Operating Temperature	0 ... + 60 °C

Absolute Maximum Ratings

Signal Input AC Voltage	50 Vpp
Reference Input Voltage	± 15 V
Control Input Voltage	- 5 V, + 30 V
Power Supply Voltage	± 22 V

Switch Settings

4 Dip Switch - Presettings	Switch OFF	ON
S1	Low Drift & High Dynamic	Ultra Stable & Low Drift
S2	1-f Mode	2-f Mode
S3	Fast PLL-Locking	Slow PLL-Locking
S4	Reference-Input-Threshold = 0 V	Reference-Input-Threshold = +2 V

Sensitivity Setting,
Output DC-Gain Modes

3 Output DC-Gain Modes are selectable:			
Mode	DC-Gain	Dyn. Reserve	DC-Stability
Ultra Stable	10	Low	High
Low Drift	100	Medium	Medium
High Dynamic	1000	High	Low

If only low dynamic reserve is required, select the higher DC-Stability settings. Use Dip switch S1 to preselect either the two upper or the two lower DC-Gain modes, then select best mode by Sensitivity switch settings 0–7 or 8–F.

Lock-In-Amplifier Module

Switch Settings (continued)

S1 = ON: Sensitivity Setting for Full Scale (= 10 V Output)

Ultra Stable Mode

Setting	Voltage	Current
0	1 V	10 μ A
1	300 mV	3 μ A
2	100 mV	1 μ A
3	30 mV	300 nA
4	10 mV	100 nA
5	3 mV	30 nA
6	1 mV	10 nA
7	300 μ V	3 nA

Low Drift Mode

Setting	Voltage	Current
8	100 mV	1 μ A
9	30 mV	300 nA
A	10 mV	100 nA
B	3 mV	30 nA
C	1 mV	10 nA
D	300 μ V	3 nA
E	100 μ V	1 nA
F	30 μ V	300 pA

S1 = OFF: Sensitivity Setting for Full Scale (= 10 V Output)

Low Drift Mode

Setting	Voltage	Current
0	100 mV	1 μ A
1	30 mV	300 nA
2	10 mV	100 nA
3	3 mV	30 nA
4	1 mV	10 nA
5	300 μ V	3 nA
6	100 μ V	1 nA
7	30 μ V	300 pA

High Dynamic Mode

Setting	Voltage	Current
8	10 mV	100 nA
9	3 mV	30 nA
A	1 mV	10 nA
B	300 μ V	3 nA
C	100 μ V	1 nA
D	30 μ V	300 pA
E	10 μ V	100 pA
F	3 μ V	30 pA

Time Constant Setting

6 dB/Oct. 12 dB/Oct. Time Constant

0	8	3 ms
1	9	10 ms
2	A	30 ms
3	B	100 ms
4	C	300 ms
5	D	1 s
6	E	3 s
7	F	10 s

Phase Shift Setting

Phase shift is adjusted by 2 phase switches with 8 Bit resolution. Values 0 ... 255 (Hex 00 ... FF) correspond to phase shift setting 0 ... +360°. One step with switch marked "Coarse" changes phase shift by 22.5°. The "Fine"-switch changes phase shift by 1.4° - steps:

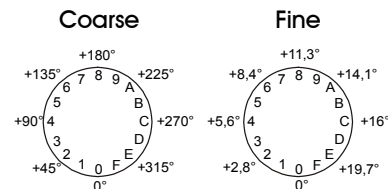

If 2-f Mode is selected, the resolution of digital phase control changes to 2.8° and the phase shift range doubles to 0 ... + 720°.

Lock-In-Amplifier Module

Internal Jumper Settings
(jumpers are accessible
when top of case is
removed)

Input Signal Filter
Setting

Set Cut-Off Frequency of Input Lowpass Filter
with JP1 + JP2 (always same position) and
Highpass Filter with JP3:

JP3	Highpass	Lowpass	
	-3 dB Cut-Off	JP1, JP2	-3 dB Cut-Off
3 – 4	0.2 Hz	1 – 2	100 Hz
1 – 3	1 Hz	3 – 4	1 kHz
2 – 4	10 Hz	5 – 6	10 kHz
3 – 5	100 Hz	7 – 8	100 kHz
4 – 6	1 kHz	none	1 MHz

Frequency Range
Selection

JP4	Frequency Range
1 – 2	normal operation
3, 4, 5, 6, 7, 8	test pins, do not use

Internal Jumper Position
Diagram
(look at top of board when
case is opened)

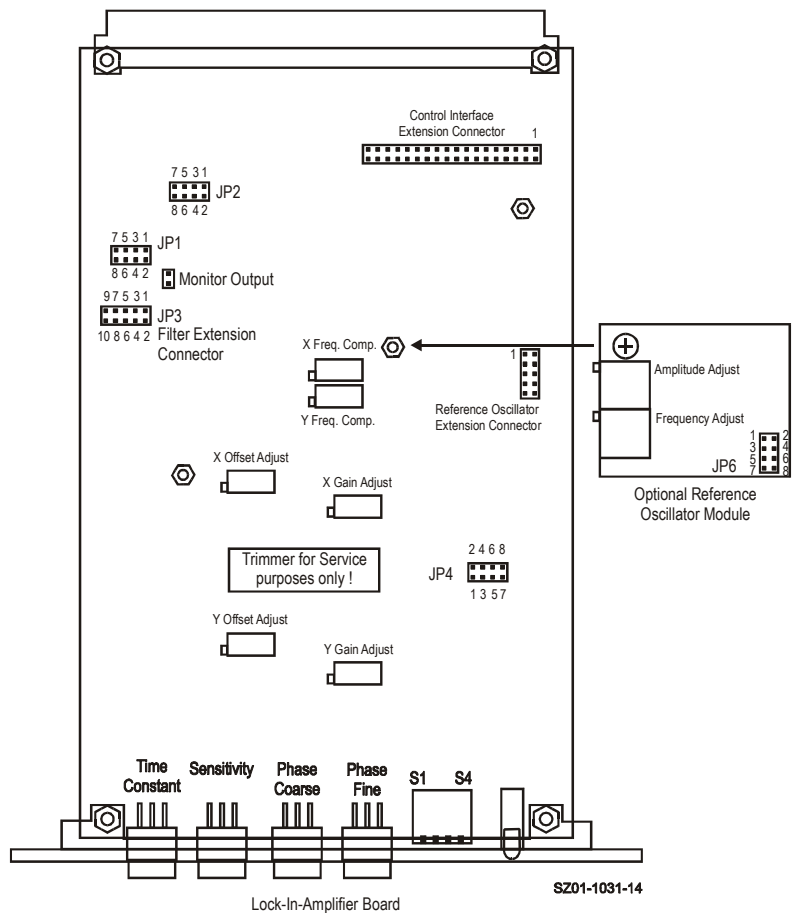

Lock-In-Amplifier Module

Internal Connector
(of build-in Lock-In Board)

Connector Type	Euro-Card DIN 41612 Connector, 64 pin male, (a+c)
Input	Pin C2: Voltage Input, Non Inverting, DC-Coupled Pin C3: Voltage Input, Non Inverting, AC-Coupled Pin C4: Voltage Input, Inverting, AC-Coupled Pin C5: Voltage Input, Inverting, DC-Coupled Pin C7: Current Input Pin C6: Current Amplifier Voltage Output Pin A2- A6: Input GND
Monitor Output	Pin C9: Monitor Output Pin A9: Monitor GND
Output	Pin C14: X-Signal Output Pin C15: Output GND
Offset Input	Pin A10: X-Offset Input Pin A13: Offset GND
Status Output	Pin C10: Unlocked Status Output Pin C11: Overload Status Output Pin C17: Status Output GND (=Power Supply GND)
Power Supply	Pin A16+C16: Power Supply – 15V Pin A18+C18: Power Supply + 15V Pin A17+C17: Power Supply GND
Remote Control Inputs (Opto-Isolated)	Pin C19: Time Constant (TC0) Pin A19: Time Constant (TC1) Pin C20: Time Constant (TC2) Pin A20: Time Constant Slope (TCSL) Pin A22: Sensitivity (SEN0) Pin C21: Sensitivity (SEN1) Pin A21: Sensitivity (SEN2) Pin C22: Dynamic Mode (DYN0) Pin A28: Phase Shift (PH0) Pin C28: Phase Shift (PH1) Pin A27: Phase Shift (PH2) Pin C27: Phase Shift (PH3) Pin A26: Phase Shift (PH4) Pin C26: Phase Shift (PH5) Pin A25: Phase Shift (PH6) Pin C25: Phase Shift (PH7) Pin C24: Disable Local Switch Control Pin A23+A24: Remote Control GND (Common Optocoupler Cathode)
Reference Input	Pin A32: Reference Input Pin A31: Reference Input Ground
Reference Output (Connected only if optional Oscillator Module is installed)	Pin A30: Reference Output Pin A17: Refer. Output GND (=Power Supply GND) Pin A29: Reference Synchronization Input
Standard Control Interface (Connected only if optional Control Interface Module (future product) is installed)	Pin C29: Interface 0 Pin C30: Interface 1 Pin C31: Interface 2 Pin C32: Interface 3

Lock-In-Amplifier Module

External Connectors
(at backside, Standard
Configuration)

Signal Input	Factory set to BNC, isolated (single ended)
X-Output	BNC
Reference Input	BNC
Power Supply	LEMO Series 1S, 3-pin fixed Socket Pin 1: + 15V Pin 2: - 15V Pin 3: GND
	
Control Port	Sub-D 25-pin, female, Qual. Class 2 Pin 1: +12V (Stabilized Power Supply Output) Pin 2: -12V (Stabilized Power Supply Output) Pin 3: AGND (Analog Ground) Pin 4: +5V (Stabilized Power Supply Output) Pin 5: X-Output Pin 6: Overload Status Output Pin 7: Unlocked Status Output Pin 8: Disable Local Switch Control Input Pin 9: DGND (Ground f. Digital Control Pin 8 - 25) Pin 10: Dynamic Mode (DYN0) Pin 11: Sensitivity (SEN0) Pin 12: Sensitivity (SEN1) Pin 13: Sensitivity (SEN2) Pin 14: Time Constant Slope (TCSL) Pin 15: Time Constant (TC0) Pin 16: Time Constant (TC1) Pin 17: Time Constant (TC2) Pin 18: Phase Shift (PH0) Pin 19: Phase Shift (PH1) Pin 20: Phase Shift (PH2) Pin 21: Phase Shift (PH3) Pin 22: Phase Shift (PH4) Pin 23: Phase Shift (PH5) Pin 24: Phase Shift (PH6) Pin 25: Phase Shift (PH7)

Connector Wiring Options

General

The BNC-connector configuration can be easily changed by setting electrical jumpers at the internal I/O-adapter card. Disconnect the power supply and open the case by loosening the two upper screws at the case front and rear side. Please pay attention to the ground connection at the backplane. Now open the case by lifting the top. The jumper options and functions are described in the following table.

Lock-In-Amplifier Module

Connector Wiring Options,
Jumpers on internal
Adapter Board

Input Connectors (JP1)

Input wiring

Jumper installed

IN A = Voltage Input (Single Ended, AC)	" +V-IN → IN A" "GND → IN A/SHLD" "-V-IN → IN A/SHLD"
IN A = Voltage Input (Differential, AC)	" +V-IN → IN A" "-V-IN → IN A/SHLD"
IN A / IN B = Voltage Input (2 BNC Differential, AC) (OUT A cannot be used)	" +V-IN → IN A" "GND → IN A/SHLD" "-V-IN → IN B"
IN A = Current Input (Single Ended)	"C-IN → IN A" "GND → IN A/SHLD" "-V-IN → C-OUT"

Output Connectors (JP2)

Output wiring

Jumper installed

OUT A = X-Output	"X → OUT A" (JP1) "USE OUT A/NO IN B"
OUT B = X-Output	"X → OUT B"
OUT A = Y-Output	"Y → OUT A" (JP1) "USE OUT A/NO IN B"
OUT B = Y-Output	"Y → OUT B"
OUT C = Y-Output	"Y → OUT C"
OUT A = R-Output	"R → OUT A" (JP1) "USE OUT A/NO IN B"
OUT B = R-Output	"R → OUT B"
OUT C = R-Output	"R → OUT C"
OUT B = Monitor Output	"MON → OUT B"
OUT C = Monitor Output	"MON → OUT C"
OUT B = Unlocked Output	"UNL → OUT B"
OUT C = Unlocked Output	"UNL → OUT C"
OUT B = Overload Output	"OVL → OUT B"
OUT C = Overload Output	"OVL → OUT C"
OUT C = Reference Output	"REF-OUT → OUT C"

Reference Connector (JP3)

Reference wiring

Jumper installed

(Reference Output only if
optional Oscillator Module
is installed)

REF = Reference Input	"REF-IN → REF" (2 Jumper)
REF = Reference Output (Reference Output connected to Ref. Input)	"REF-OUT → REF-IN" (2 Jp.) "REF-IN → REF" (2 Jumper)
REF = Refer. Sync. Input (use OUT C as Reference Output)	"REF-SYNC → REF" (2 Jp.)

Lock-In-Amplifier Module

Remote Control Operation

General

Remote Control Input Bits are opto-isolated and connected by logical OR to local switch setting. The 4 hexadecimal switches are 4 Bit-coded as shown in the following table:

Switch Code	MSB		LSB	
	Bit 3	Bit 2	Bit 1	Bit 0
0	Low	Low	Low	Low
1	Low	Low	Low	High
2	Low	Low	High	Low
3	Low	Low	High	High
4	Low	High	Low	Low
5	Low	High	Low	High
6	Low	High	High	Low
7	Low	High	High	High
8	High	Low	Low	Low
9	High	Low	Low	High
A	High	Low	High	Low
B	High	Low	High	High
C	High	High	Low	Low
D	High	High	Low	High
E	High	High	High	Low
F	High	High	High	High

For remote control a switch setting, set the local switch to "0" and select the wanted setting via the 4-Bit-code at the corresponding digital inputs.

Sensitivity Switch -
Corresponding Inputs

Bit	Corresponding Control Port Input	
Bit 0	SEN0	(Pin A22)
Bit 1	SEN1	(Pin C21)
Bit 2	SEN2	(Pin A21)
Bit 3	DYNO	(Pin C22)

Time Constant Switch -
Corresponding Inputs

Bit	Corresponding Control Port Input	
Bit 0	TC0	(Pin C19)
Bit 1	TC1	(Pin A19)
Bit 2	TC2	(Pin C20)
Bit 3	TCSL	(Pin A20)

Phase Switch Coarse -
Corresponding Inputs

Bit	Corresponding Control Port Input	
Bit 0	PH4	(Pin A26)
Bit 1	PH5	(Pin C26)
Bit 2	PH6	(Pin A25)
Bit 3	PH7	(Pin C25)

Phase Switch Fine -
Corresponding Inputs

Bit	Corresponding Control Port Input	
Bit 0	PH0	(Pin A28)
Bit 1	PH1	(Pin C28)
Bit 2	PH2	(Pin A27)
Bit 3	PH3	(Pin C27)

Remote Control Example

For example, to select a switch setting code "6", you have to connect a "High"- level signal to the corresponding control input pins Bit 1 & Bit 2. Mixed operation, e.g. local phase settings and remote controlled sensitivity setting, is also possible.

Lock-In-Amplifier Module

Dimensions

Top View

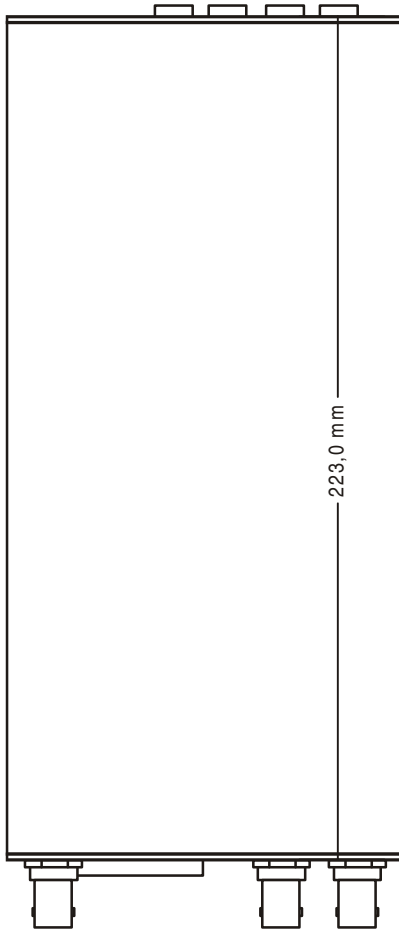

Front View

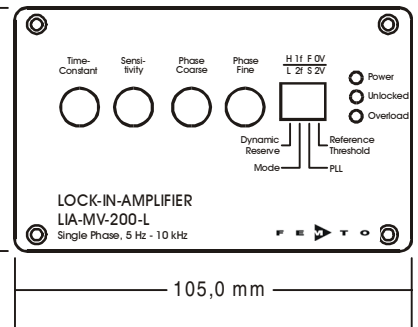

Back View

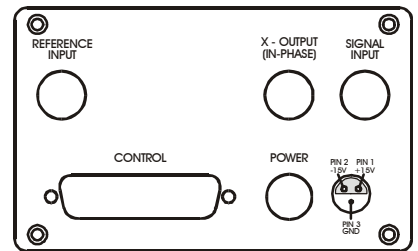

Case Material:
Al, natural anodised

DZ01-1071-10

Optional Extensions

Reference Oscillator Module

Model No.: SOM-1

- Frequency Range 5 Hz ... 130 kHz, User adjustable
- Output Voltage 0 ... 2 Vrms, User adjustable
- 100 ppm/K Amplitude Accuracy

Factory Set

1 kHz, 1 Vrms

FEMTO Messtechnik GmbH
Klosterstr. 64
D-10179 Berlin · Germany
Tel.: +49-(0)30-280 4711-0
Fax: +49-(0)30-280 4711-11
e-mail: info@femto.de
http://www.femto.de

Specifications are subject to change without notice. Information furnished herein is believed to be accurate and reliable. However, no responsibility is assumed by FEMTO Messtechnik GmbH for its use, nor for any infringement of patents or other rights granted by implication or otherwise under any patent rights of FEMTO Messtechnik GmbH. Product names mentioned may also be trademarks used here for identification purposes only.

© by FEMTO Messtechnik GmbH
Printed in Germany



Datasheet

LUCI-10

**USB to D-Sub Control Interface
for FEMTO Amplifiers**



<p>Features</p>	<ul style="list-style-type: none"> • Compact digital I/O interface for USB remote control of FEMTO amplifiers • Supports opto-isolation of amplifier signal path from PC USB port • 16 digital outputs, 3 opto-isolated digital inputs • Bus-powered operation • System driver, application software and VI's for use with LabVIEW™ included 				
<p>Applications</p>	<ul style="list-style-type: none"> • Remote control of FEMTO® amplifiers and photoreceivers directly from a PC 				
<p>Block Diagram</p>	<p style="text-align: right; font-size: small;">BS-LUCI-10_R1</p>				
<p>Hardware Specifications</p>	<table border="0"> <tr> <td style="vertical-align: top;"> <p>General Characteristics</p> </td> <td> <p>Bus interface: USB 2.0 (full-speed)</p> <p>Digital I/O channels: 16 output lines, 3 opto-isolated input lines</p> <p>Supply: PC USB port, +5 V, typ. 100 mA, bus-powered (no auxiliary power supply required)</p> <p>Connectors: USB type A, D-Sub, 25 pin, male</p> <p>Cable: AWG 28, length 1.8 m</p> </td> </tr> <tr> <td style="vertical-align: top;"> <p>Output</p> </td> <td> <p>Number of channels: 16 output lines, supporting opto-isolation inside FEMTO amplifiers and photoreceivers</p> <p>Output voltage range: LOW bit: 0 ... +0.5 V (@ 0 ... 2 mA output current), HIGH bit: +4 ... +5.5 V (@ 0 ... 2 mA output current)</p> <p>Max. current: 6 mA per channel</p> <p>Writing rate: max. 600 operations per second</p> </td> </tr> </table>	<p>General Characteristics</p>	<p>Bus interface: USB 2.0 (full-speed)</p> <p>Digital I/O channels: 16 output lines, 3 opto-isolated input lines</p> <p>Supply: PC USB port, +5 V, typ. 100 mA, bus-powered (no auxiliary power supply required)</p> <p>Connectors: USB type A, D-Sub, 25 pin, male</p> <p>Cable: AWG 28, length 1.8 m</p>	<p>Output</p>	<p>Number of channels: 16 output lines, supporting opto-isolation inside FEMTO amplifiers and photoreceivers</p> <p>Output voltage range: LOW bit: 0 ... +0.5 V (@ 0 ... 2 mA output current), HIGH bit: +4 ... +5.5 V (@ 0 ... 2 mA output current)</p> <p>Max. current: 6 mA per channel</p> <p>Writing rate: max. 600 operations per second</p>
<p>General Characteristics</p>	<p>Bus interface: USB 2.0 (full-speed)</p> <p>Digital I/O channels: 16 output lines, 3 opto-isolated input lines</p> <p>Supply: PC USB port, +5 V, typ. 100 mA, bus-powered (no auxiliary power supply required)</p> <p>Connectors: USB type A, D-Sub, 25 pin, male</p> <p>Cable: AWG 28, length 1.8 m</p>				
<p>Output</p>	<p>Number of channels: 16 output lines, supporting opto-isolation inside FEMTO amplifiers and photoreceivers</p> <p>Output voltage range: LOW bit: 0 ... +0.5 V (@ 0 ... 2 mA output current), HIGH bit: +4 ... +5.5 V (@ 0 ... 2 mA output current)</p> <p>Max. current: 6 mA per channel</p> <p>Writing rate: max. 600 operations per second</p>				

**USB to D-Sub Control Interface
for FEMTO Amplifiers**

<p>Input</p>	<p>Number of channels Input voltage range</p> <p>Switching current Reading rate</p>	<p>3 opto-isolated input lines LOW bit: -20 ... +1.5 V HIGH bit: +3 ... +20 V 1 mA typ. @ 5 V max. 300 operations per second</p>
<p>Power Supply</p>	<p>USB port, bus powered Active current Suspend current</p>	<p>+4.5 ... +5.5 V DC max. 200 mA / typ. 100 mA <0.5 mA (standby mode of Windows®)</p>
<p>Case</p>	<p>D-Sub case Weight Material</p>	<p>metal hood (EMI/RFI shielding), with jack screws 130 g (0.3 lb.) zinc die-cast, nickel plated</p>
<p>Temperature Range</p>	<p>Storage temperature Operating temperature</p>	<p>-40 ... +100 °C 0 ... +50 °C</p>
<p>Absolute Maximum Ratings</p>	<p>Max. voltage at input Max. short-circuit output current Max. isolation voltage</p>	<p>±30 V ±20 mA per channel, 200 mA total ±60 V (input ground to output ground)</p>
<p>Connectors</p>	<p>Device port</p> <p>PC port</p>	<p>D-Sub, 25 pin, male Pin 1: NC Pin 2: NC Pin 3: GND (IN) Pin 4: NC Pin 5: Digital IN Pin 6: Digital IN Pin 7: Digital IN Pin 8: NC Pin 9: GND (OUT) Pin 10: Digital OUT Low Byte, LSB Pin 11: Digital OUT Low Byte Pin 12: Digital OUT Low Byte Pin 13: Digital OUT Low Byte Pin 14: Digital OUT Low Byte Pin 15: Digital OUT Low Byte Pin 16: Digital OUT Low Byte Pin 17: Digital OUT Low Byte, MSB Pin 18: Digital OUT High Byte, LSB Pin 19: Digital OUT High Byte Pin 20: Digital OUT High Byte Pin 21: Digital OUT High Byte Pin 22: Digital OUT High Byte Pin 23: Digital OUT High Byte Pin 24: Digital OUT High Byte Pin 25: Digital OUT High Byte, MSB</p> <p>USB type A</p>

USB to D-Sub Control Interface for FEMTO Amplifiers

Software Specifications

Software
(included on CD)

Device driver	dynamic link library (DLL) for integration in Microsoft Windows® 32 bit & 64 bit operating system for use with C/C++, LabWindows™ /CVI™ or LabVIEW™
Application software	GUI (graphical user interface) programs for simple remote control of FEMTO amplifiers and photoreceivers provided as executable programs and LabVIEW projects
LabVIEW programs	sample programs to control and test the LUCI-10 hardware (including front panel and block diagram)
LabVIEW library	special VI toolkit for integration in LabVIEW 32 bit & 64 bit development environment

Note: A National Instruments LabVIEW™ license is not included in this software package. For use of the GUI application programs the LabVIEW Run-Time Engine is required. If not detected on the host PC during the installation process the LabVIEW Run-Time Engine will be installed automatically from the CD.

System Requirements

Operating system	Microsoft Windows XP with Service Pack 3, or higher
Processor	Intel Pentium III or AMD Athlon, or better
System memory	1 GB of RAM, or more
Hard disk space	about 5 GB
Interface port	USB 1.1 or USB 2.0
Supported FEMTO modules	any standard FEMTO amplifier or photoreceiver with 25 pin D-Sub socket, except model HLVA-100

Optional Requirements

For development of own application programs an additional development environment like LabVIEW Version 2012 (or higher) or C/C++ is required.

Legal Notice

LabVIEW, CVI, National Instruments and NI are trademarks of National Instruments. Neither FEMTO Messtechnik GmbH, nor any software programs or other goods or services offered by FEMTO Messtechnik GmbH, are affiliated with, endorsed by, or sponsored by National Instruments.

The mark LabWindows is used under a license from Microsoft Corporation. Microsoft and Windows are either registered trademarks or trademarks of Microsoft Corporation in the United States and/or other countries.

FEMTO and the FEMTO logo are trademarks or registered trademarks of FEMTO Messtechnik GmbH in Germany, the U.S. and/or other countries.

Product and company names mentioned may also be trademarks or trade names of their respective companies used here for identification purposes only.

USB to D-Sub Control Interface for FEMTO Amplifiers

Dimensions

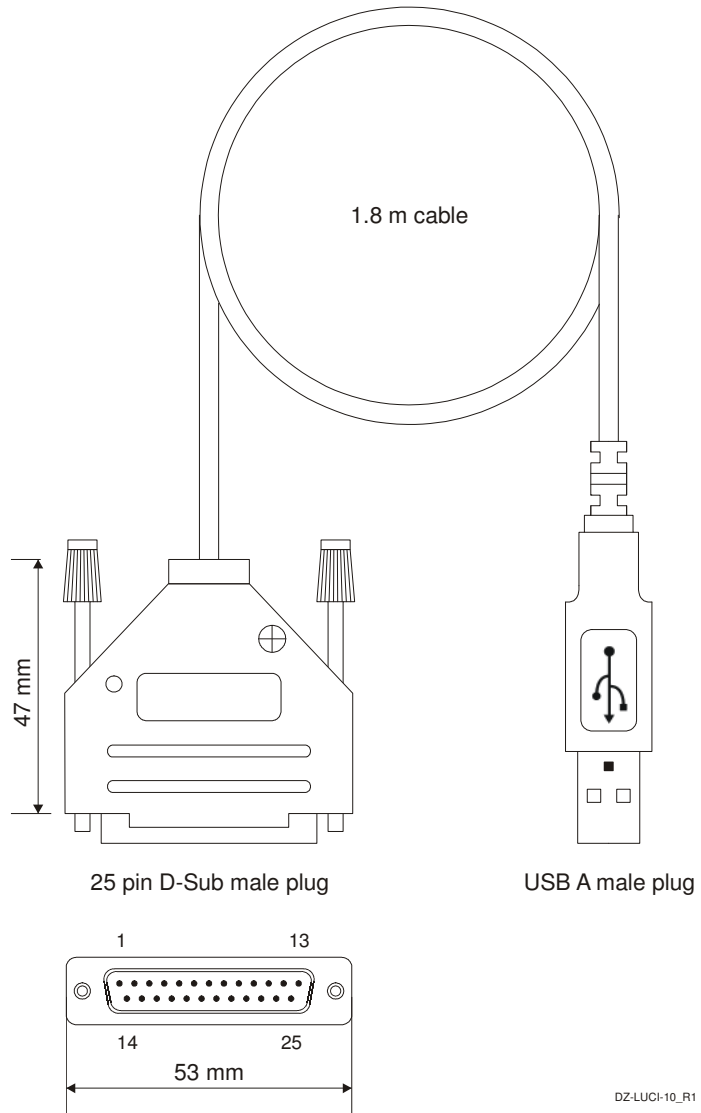

Specifications are subject to change without notice. Information provided herein is believed to be accurate and reliable. However, no responsibility is assumed by FEMTO Messtechnik GmbH for its use, nor for any infringement of patents or other rights of third parties which may result from its use. No license is granted by implication or otherwise under any patent or patent rights of FEMTO Messtechnik GmbH. Product names mentioned may also be trademarks used here for identification purposes only.

© by FEMTO Messtechnik GmbH · Printed in Germany