



# Electro Optical Components, Inc.

5464 Skylane Boulevard, Suite D, Santa Rosa, CA 95403

Toll Free: 855-EOC-6300

[www.eoc-inc.com](http://www.eoc-inc.com) | [info@eoc-inc.com](mailto:info@eoc-inc.com)



## Mid-Infrared Light Emitting Diode

1,90 - 1,99  $\mu\text{m}$

### Lms19LED

Parameters	Units	Conditions	Ratings		
			Min	Typ	Max
Peak emission wavelength	$\mu\text{m}$	T=300 K, I = 150 mA qCW	1,90	1,95	1,99
FWHM of the emission band	nm	I = 150 mA qCW	100	150	200
Quasi-CW Optical Power	mW	I = 200 mA qCW	0,8	1,0	1,2
Pulsed Peak Optical Power	mW	I=1 A, f=1 kHz, duty cycle 0.1%	20	25	30
Voltage	V	T=300 K, I=200 mA	0,5	-	1,5
Switching time	ns	T=300 K	10	20	30
Operating temperature range	$^{\circ}\text{C}$	-200...+50			
Soldering temperature	$^{\circ}\text{C}$	180			

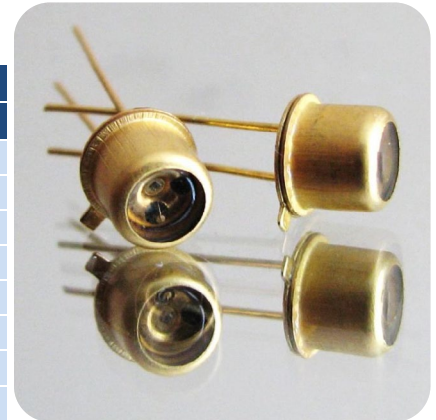

Light Emitting Diodes Lms19LED series are fabricated from narrow band-gap GaInAsSb/AlGaAsSb heterostructures lattice matched to GaSb substrate.

Spectra at different currents (qCW, T=300 K)

Spectra at different temperatures (qCW, I=150 mA)

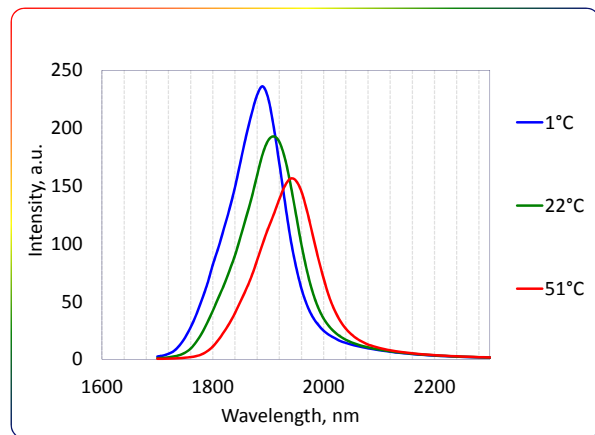
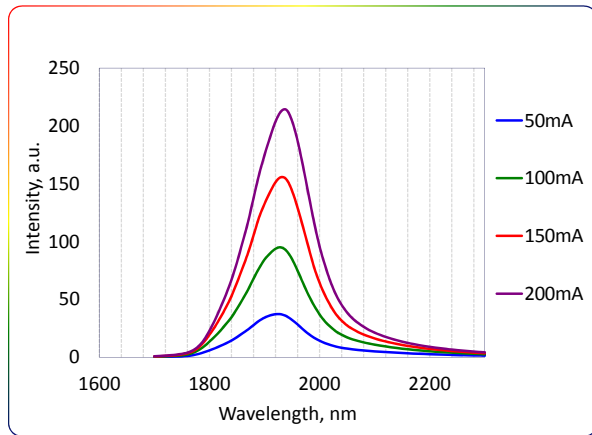

LED Power Characteristic (quasi-CW mode, T=300K)

LED Typical Current-Voltage Characteristics (T=300K)

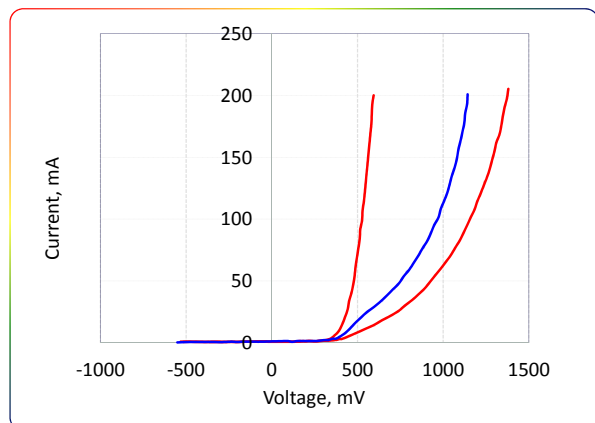
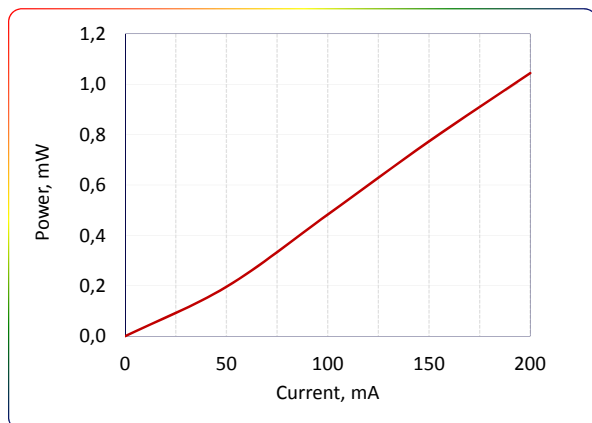

Packages	Model
TO-18 with a cap with a glass window	Lms MIR LED
TO-18 with a parabolic reflector without a window	Lms MIR LED-R
TO-18 with a parabolic reflector with a glass window	Lms MIR LED-RW
TO-5 with a built-in thermocooler and thermoresistor, covered by a cap with a glass window	Lms MIR LED-TEM
TO-5 with a built-in thermocooler and thermoresistor, covered by a parabolic reflector with a glass window	Lms MIR LED-TEM-R

### Beam Divergence (Far-field pattern)

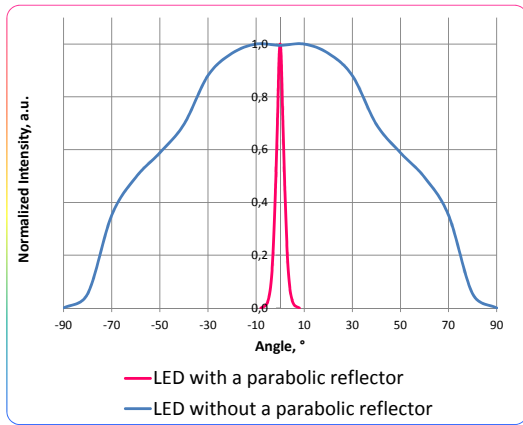

### Technical Drawing

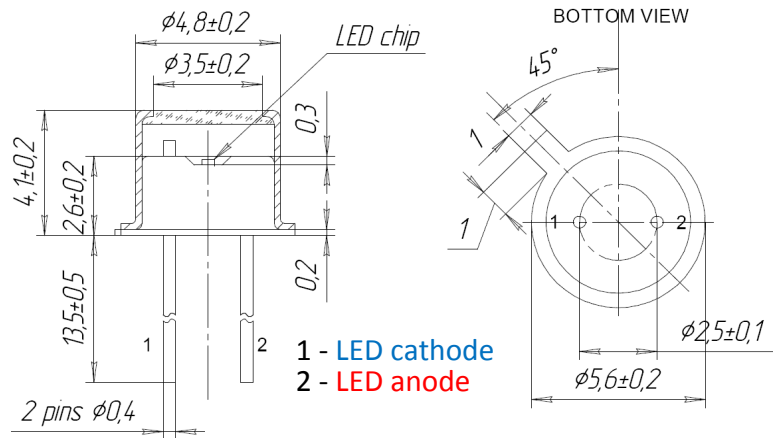

To drive the LED we recommend to use:

#### • LED basic circuit connection

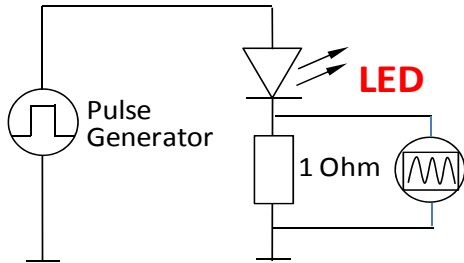

#### • LED drivers and evaluation boards designed by LED Microsensor NT

We recommend to use Quasi Continuous Wave (qCW) mode with duty cycle 50% or 25% to obtain maximum average optical power and short Pulse modes to obtain maximum peak power. Hard CW (continius wave) mode is NOT recommended.

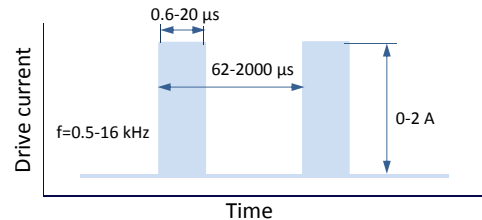
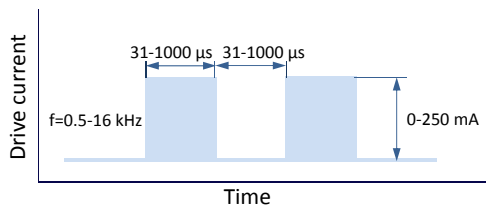

### IMPORTANT CAUTIONS:

- Please check your connection circuit before turning on the LED
- Please observe the LED polarity: LED anode is marked with a RED dot
- Please do not connect the LED to the multimeter