



Electro Optical Components, Inc.

5464 Skylane Boulevard, Suite D, Santa Rosa, CA 95403

Toll Free: 855-EOC-6300

www.eoc-inc.com | info@eoc-inc.com



Mid-Infrared Light Emitting Diode

2,20 - 2,29 μm

Lms22LED

Parameters	Units	Conditions	Ratings		
			Min	Typ	Max
Peak emission wavelength	μm	T=300 K, I = 150 mA qCW	2,20	2,22	2,29
FWHM of the emission band	nm	I = 150 mA qCW	150	200	250
Quasi-CW Optical Power	mW	I = 200 mA qCW	0,7	1,0	1,2
Pulsed Peak Optical Power	mW	I=1 A, f=1 kHz, duty cycle 0.1%	15	20	25
Voltage	V	T=300 K, I=200 mA	0,5	-	1,0
Switching time	ns	T=300 K	10	20	30
Operating temperature range	$^{\circ}\text{C}$	-200...+50			
Soldering temperature	$^{\circ}\text{C}$	180			

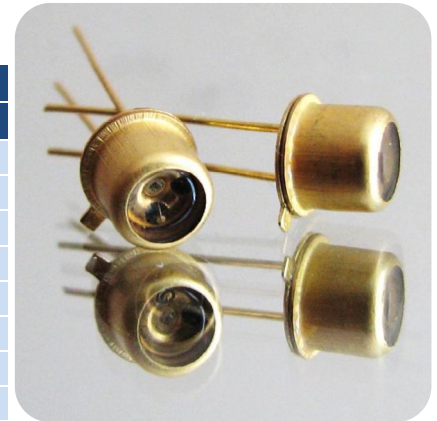

Light Emitting Diodes **Lms22LED** series are fabricated from narrow band-gap GaInAsSb/AlGaAsSb heterostructures lattice matched to GaSb substrate.

Spectra at different currents (qCW, T=300 K)

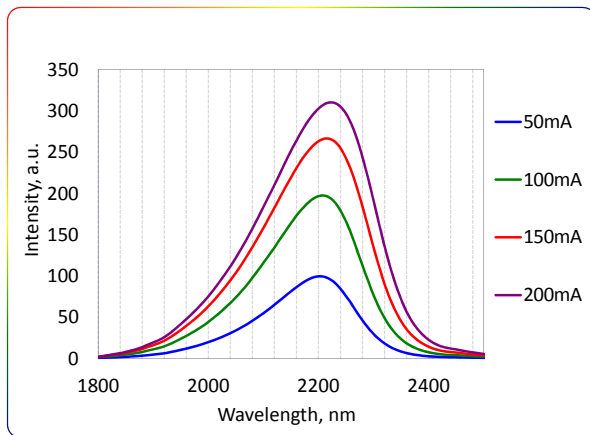

Spectra at different temperatures (qCW, I=150 mA)

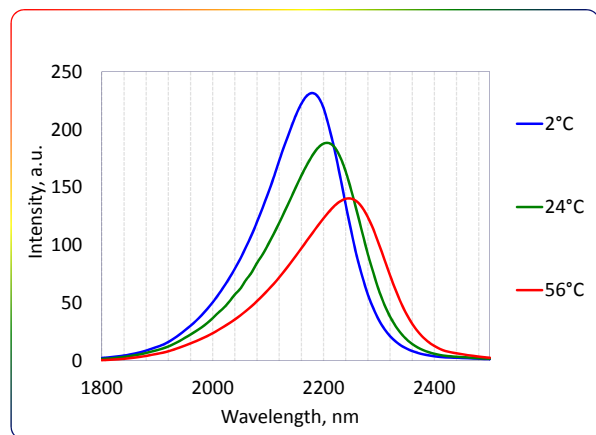

LED Power Characteristic (quasi-CW mode, T=300K)

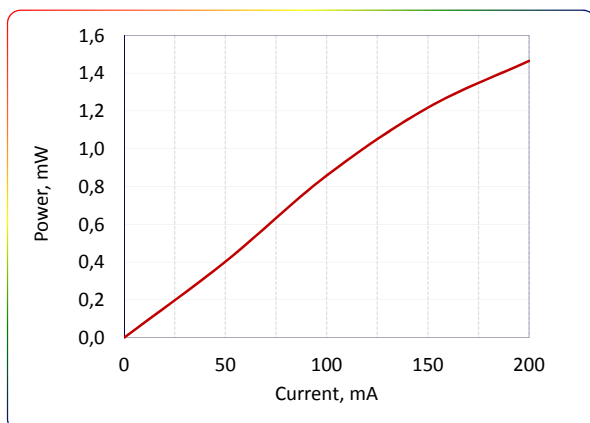

LED Typical Current-Voltage Characteristics (T=300K)

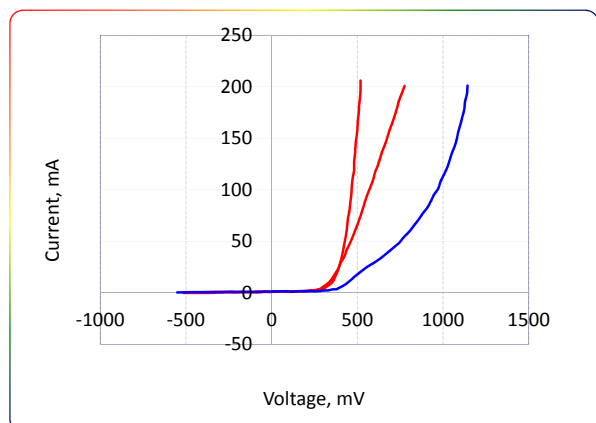

Packages	Model
TO-18 with a cap without a window	Lms MIR LED
TO-18 with a parabolic reflector without a window	Lms MIR LED-R
TO-18 with a parabolic reflector with a glass window	Lms MIR LED-RW
TO-5 with a built-in thermocooler and thermoresistor, covered by a cap with a glass window	Lms MIR LED-TEM
TO-5 with a built-in thermocooler and thermoresistor, covered by a parabolic reflector with a glass window	Lms MIR LED-TEM-R

Beam Divergence (Far-field pattern)

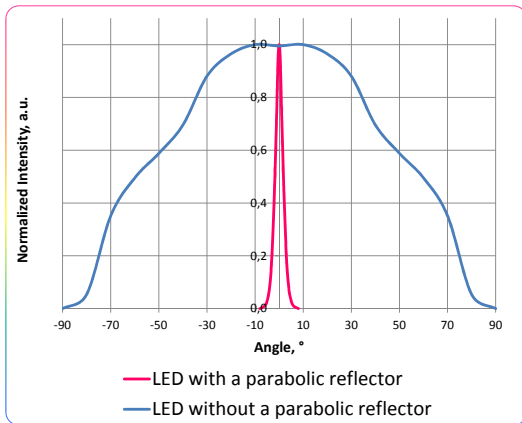

Technical Drawing

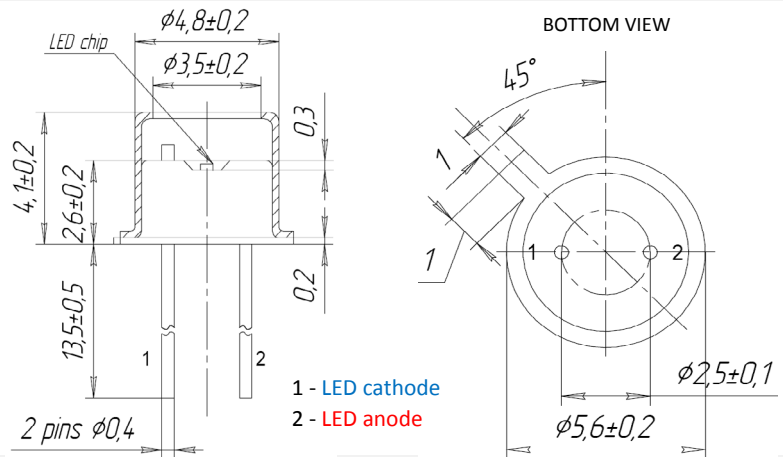

To drive the LED we recommend to use:

• LED basic circuit connection

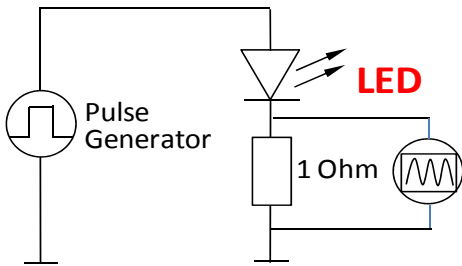

• LED drivers and evaluation boards designed by LED Microsensor NT

We recommend to use **Quasi Continuous Wave (qCW) mode** with duty cycle 50% or 25% to obtain maximum average optical power and short **Pulse modes** to obtain maximum peak power. **Hard CW (continuous wave) mode is NOT recommended.**

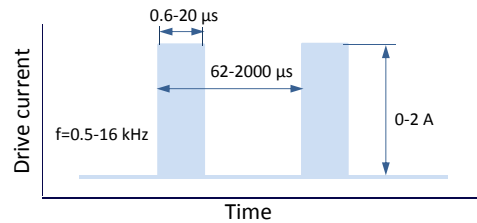
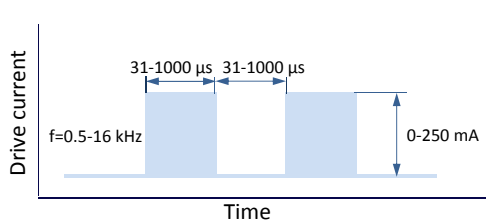

IMPORTANT CAUTIONS:

- Please check your connection circuit before turning on the LED
- Please observe the LED polarity: LED anode is marked with a RED dot
- Please do not connect the LED to the multimeter