



Electro Optical Components, Inc.

5464 Skylane Boulevard, Suite D, Santa Rosa, CA 95403

Toll Free: 855-EOC-6300

www.eoc-inc.com | info@eoc-inc.com



Features

- High reliability
- Superior linearity
- Thermo stability
- Easy-to-use detector/amplifier modules are also available

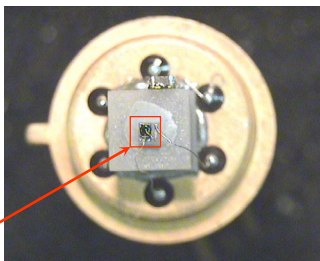

Photodiode CHIP

Description

Photodiode **PD36-03-TEC** is a model of photodetector for detection of radiation at room temperature in the Middle Infrared (Mid-IR) spectral range from 1500 to 3800 nm.

Photodiode **PD36-03-TEC** has thermo electric cooler (TEC) and termistor for a control of temperature. Components are integrated inside the standard 9.2 mm TO-5 package with TEC.

Diameter of the photosensitive area of **PD36-03-TEC** is 300 μm . High speed of response makes it possible for detection of modulated radiation of laser diodes (LDs) and light-emitting diodes (LEDs).

Related products: **PD36-03-TEC** can be used in optical pair with our **LED185...LED36**.

General characteristics

Package	Parameter	Symbol	Value	Unit
TO-5 with TEC	Sensitive area diameter	d	0.3	mm
	Weight	m	1.15	g
	Operating temperature	T _{opr}	- 20...+ 40	°C
	Window material		sapphire glass	
	Cooling		one-stage TE-cooled	
	Soldering temperature	T _s	+ 230	°C
	Storage temperature	T _{stg}	- 20...+ 50	°C
	Maximum reverse bias voltage	V _b	- 1.0	V
	Size	D	9.2	mm
H		20.2		

PHOTODIODE with TEC PD36-03-TEC

1.5 - 3.8 μm

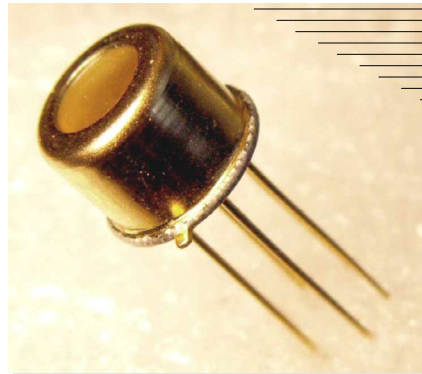

Applications

- Invironment measurements
- Infared spectrophotometry
- Laser detection
- Analytical instruments

Accessories (optional)

- Amplifier with temperature controller
AMT-07M

Electrical and optical characteristics

Parameter	Symbol	Condition	Element temperature			Unit
			- 20 °C	0 °C	+ 20 °C	
Spectral sensitivity range	λ	at level 10%	1.5* - 3.6	-	1.5* - 3.8	μm
Peak sensitivity wavelength	λ_p	at level 90%	2.5 - 3.3	-	2.6 - 3.4	μm
Photo sensitivity	S	at λ_p	1.0 - 1.2			A/W
Detectivity	D^*	at λ_p	$[0.6 - 1.0] \cdot 10^{10}$	-	$[3 - 6] \cdot 10^9$	$\text{cm} \cdot \text{Hz}^{1/2} \cdot \text{W}^{-1}$
Dark current	I_d	$V_b = - 0.2 \text{ V}$	40 - 90	-	150 - 350	μA
		$V_b = - 0.4 \text{ V}$	90 - 150	-	200 - 500	
Capacitance	C	$V_b = 0 \text{ V}$, $f = 1 \text{ MHz}$	70 - 1000			μF
Rise time	t_r	$V_b = 0 \text{ V}$, $R_L = 50 \Omega$	20 - 120			ns
Fall time	t_f					
Shunt resistance	R_0	$V_b \approx \pm [5 - 10] \text{ mV}$	900 - 6700	-	100 - 1200	Ω
Noise equivalent power	NEP	at λ_p	-	-	-	$\text{W} \cdot \text{Hz}^{-1/2}$

TEC TO506.1MC0400710.TB103 parameters (without load)

Parameter	Symbol	Condition	Value	Unit
Current power	I_{max}	ΔT_{max}	1.50	A
Voltage	U_{max}	ΔT_{max}	0.80	V
Cooling energy	Q_{max}	-	1.30	W
Temperature range	ΔT_{max}	vacuum	70	K
Termistor resistance	R_t	at + 20 °C	10.00	k Ω

Spectral response

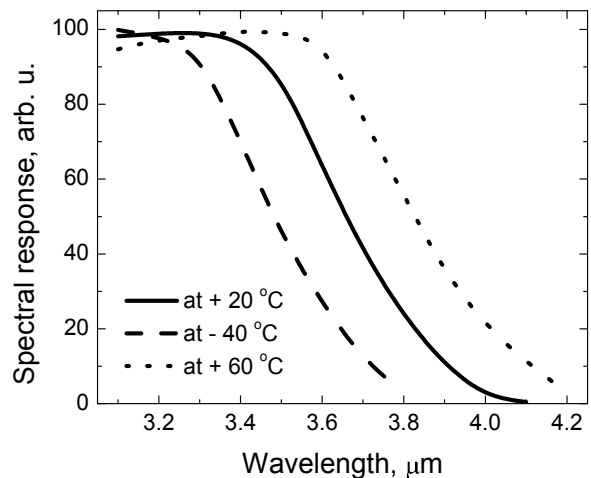
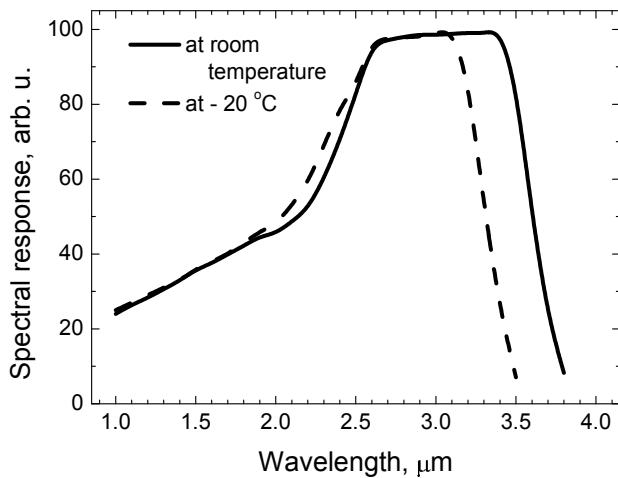

Shunt resistance vs. element temperature

Capacitance vs. reverse voltage

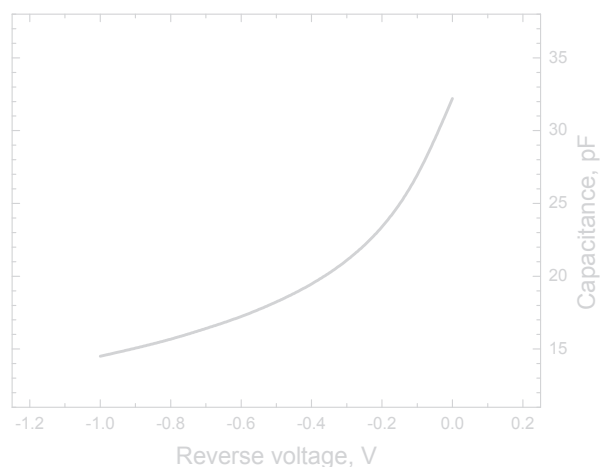
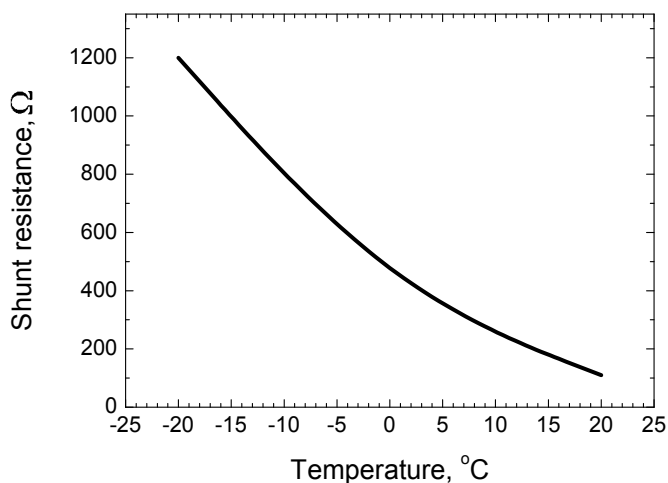

Dark current vs. reverse voltage

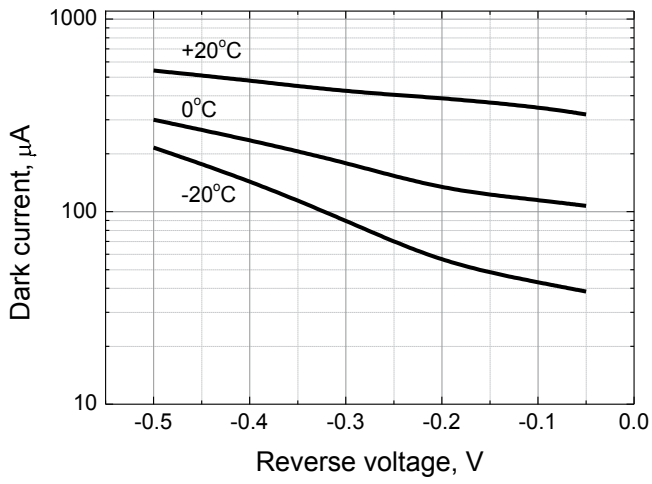

Thermoresistance vs. temperature

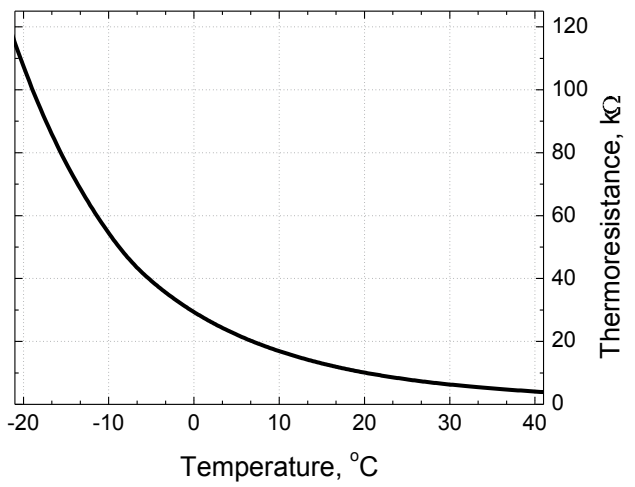

TO-5 package with TEC dimensions (unit: mm)

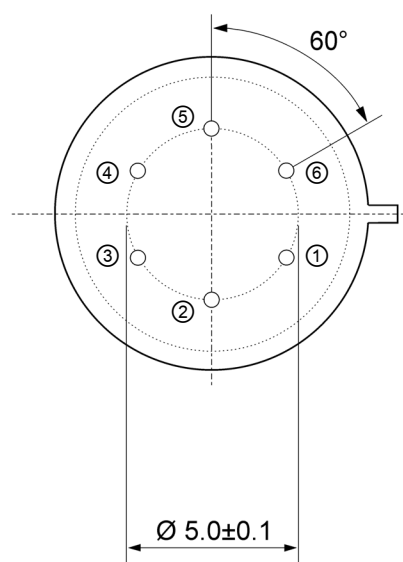
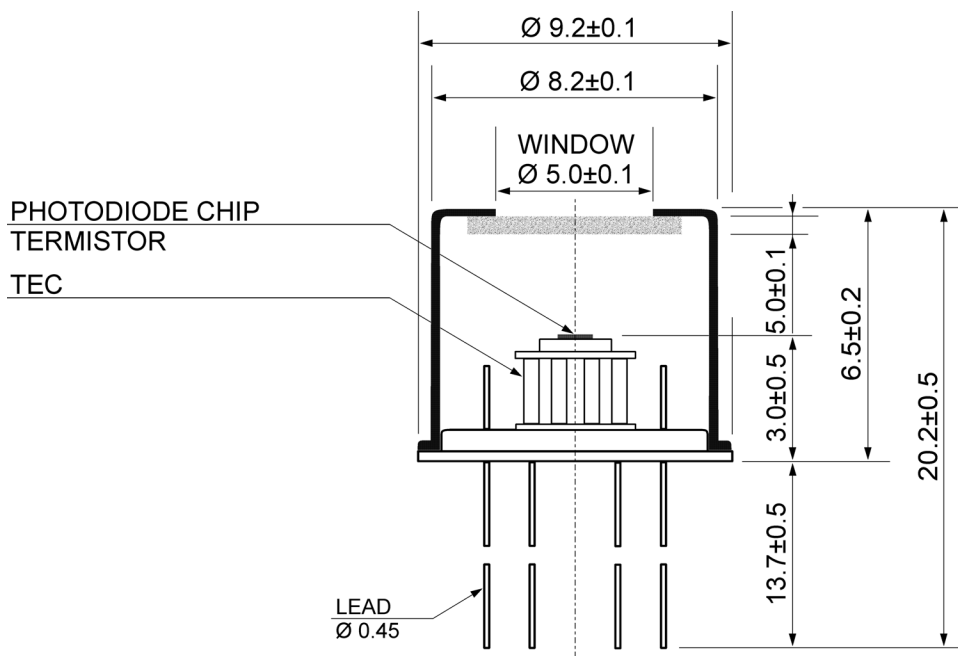

Pin	Description
①	TEC (anode)
②	Detector (anode)*
③	Detector (cathode)*
④	Termistor TC103
⑤	
⑥	TEC (catnode)

*Special order: the pin polarity can be changed.