



Electro Optical Components, Inc.

5464 Skylane Boulevard, Suite D, Santa Rosa, CA 95403

Toll Free: 855-EOC-6300

www.eoc-inc.com | info@eoc-inc.com



P200 ORANGE EDITION GENERAL SPECIFICATIONS

MICRO PUMP ORANGE EDITION FROM XAVITECH

ORANGE Edition is suitable for those who need a high quality micro pump and can manage with a somewhat limited service lifespan. ORANGE Edition has a defined service lifespan of 1,000 hours and a fixed interface with your system.

- Affordable solution
- Guaranteed service lifespan
- Highest quality

MICRO PUMP WITH GUARANTEED FUNCTION OF 1,000 HOURS

It can be frustrating to need to adapt your product to variations in the service lifespans of pumps. With the ORANGE Edition, you get a micro pump that is guaranteed to work for the full 1,000 hours it was designed to do, at a very good price. In this way, you do not need to pay for pumps with longer service lifespans in order to be assured that the pump will actually work for the stated number of hours.

ORANGE EDITION PROVIDES HIGH QUALITY AT AN AFFORDABLE PRICE

Xavitech's belief in high quality pervades this pump version. Flexibility is limited in the ORANGE Edition, which allows for such an affordable price. It is sold in a limited number of standard designs for each pump model. If this is too limiting, then we suggest you check out our BLACK edition instead.

GENERAL FLOW PERFORMANCE P200 PUMPS

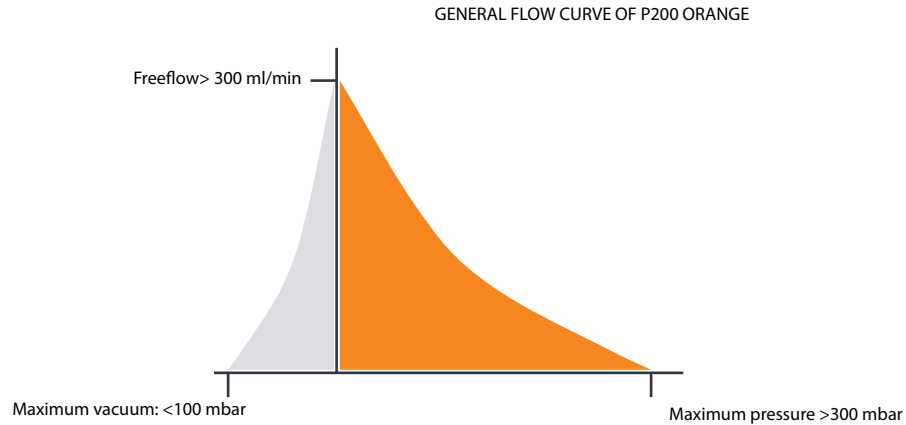

PUMP MODEL	P200 ORANGE EDITION
PERMISSABLE AMBIENT TEMP	0 - 55 C
PERMISSABLE MEDIUM TEMP	0 - 55 C
FLOW MEDIA	Air and gas.
WETTED PARTS	EPDM and PPS
CAPACITORS	Missing VCC capacitor can damage the pump. See electrical interface datasheet
CONNECTIONS	Incorrect lead connection can damage the pump
FILTERS	To insure lifetime, air filters should be used in order to prevent contaminations like dust to enter the pump
FLOW TOLERANCES	Flow can vary -/+ 10% of maximum specification between individual pumps
VACUUM AND PRESSURE TOLERANCES	Vacuum and pressure can vary -/+ 10% of maximum specification between individual pumps
PUMP FLOW	Flow can only be in one direction and can not be reversed

STANDARD MODELS (Part number)

The ORANGE version is only available in fixed voltages and can not be customized on flow calibration. The lifetime is also fixed. Choose the BLACK edition if more flexible solutions is required.

MODEL	VOLTAGE (DC)	FLOW (ml/min)	MAX PRESSURE (mbar)	CONNECTION INTERFACE	ANALOG FLOW CONTROL	SERIAL INTERFACE (RS-232)	LIFE TIME (Hours)
P200-O2C5V	5V	>300	>300	2 Wires	NO	NO	1000
P200-O2C12V	12V	>300	>300	2 Wires	NO	NO	1000

P200 ORANGE edition. 12V DC version

Current Vs Voltage (@ maximum freeflow)

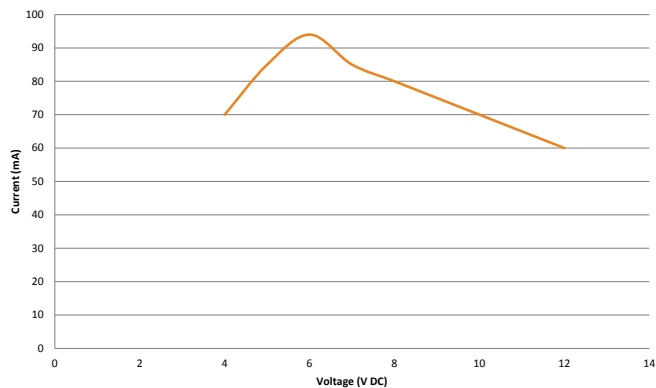

Maximum flow Vs. Voltage

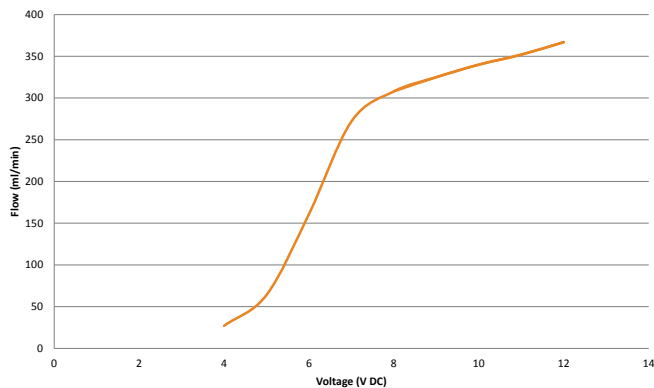

Max pressure Vs. Voltage (@ maximum freeflow)

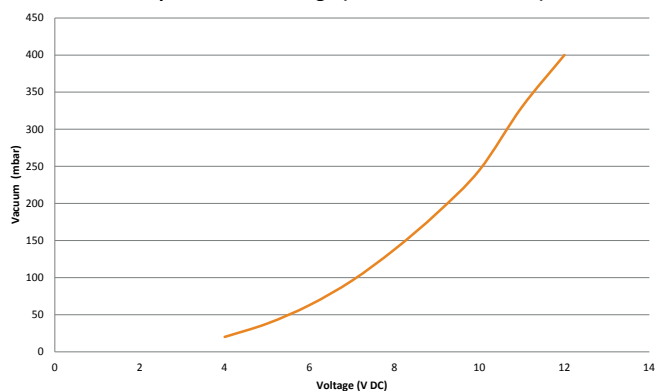

P200 ORANGE edition. 5V DC version

Current Vs Voltage

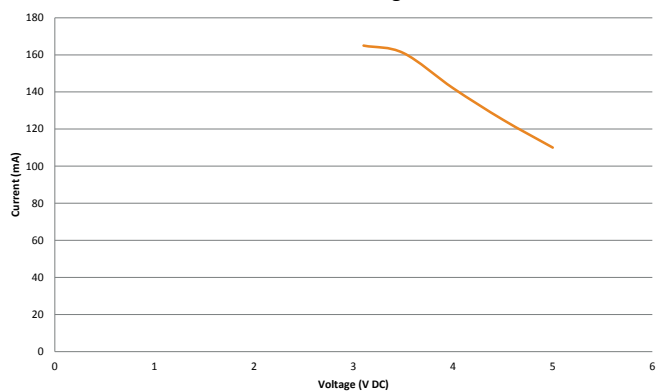

Maximum flow Vs. Voltage

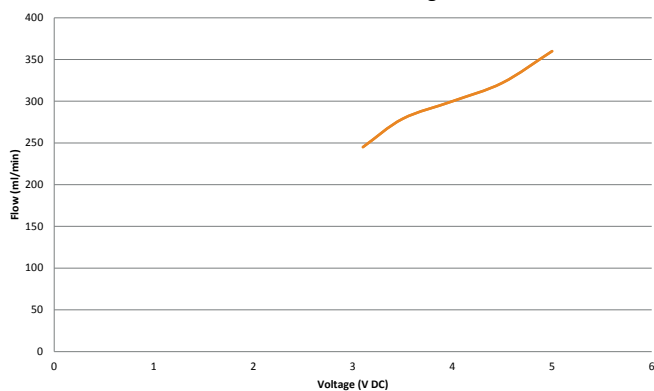

Max pressure Vs. Voltage (@ maximum freeflow)

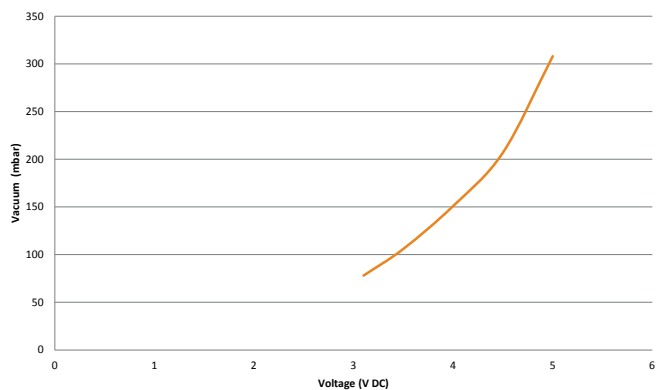

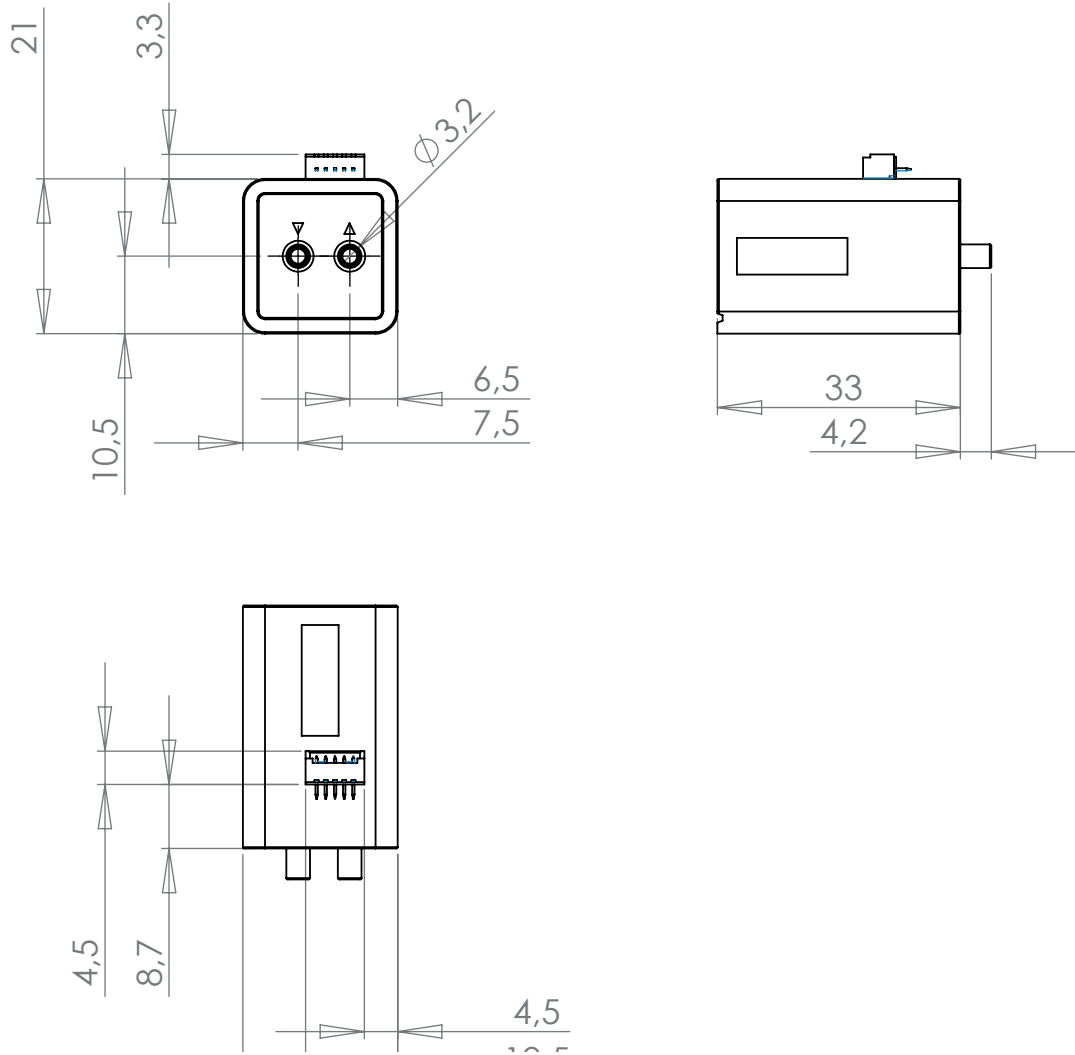

ALL DIMENSIONS ARE IN MM

PUMP MODEL	V200 AND P200 ORANGE EDITION
CONNECTION	2 wires
DRAWING SCALE	1:1
DIMENSION TOLERANCE	+/- 0,2mm
PUMP WEIGHT	40g +/- 2g
RECOMMENDED CONNECTORS	MOLEX 53047 (picoblade)
RECOMMENDED TUBE ID	1,6 to 2,8mm (Material dependent)