



## Pyroelectric Low Noise Flame Detector PS1x3C2-A-D3.7

Pyroelectric one-channel current mode detector for flame detection with large active area and bipolar low noise circuit.

Active Area	1.65 x 1.65	mm <sup>2</sup>
Aperture	Ø 3.7	mm <sup>2</sup>
Mode	Current	
Time Constant $t_{(0-63\%)} \text{ thermal}$	typ. 62	ms
Time Constant $t_{(0-63\%)} \text{ electrical}$	typ. 2	ms
AC Sensitivity <sup>1,2,3</sup>	typ. 275000	V/W
Noise Density Voltage <sup>1</sup>	typ. 105	$\mu\text{V}/\text{Hz}^{1/2}$
Noise Equivalent Power NEP <sup>1,2,3</sup>	typ. $3.82 \times 10^{-10}$	W/Hz <sup>1/2</sup>
Specific Detectivity $D^* \text{ }^{1,2,3}$	typ. $4.32 \times 10^8$	cmHz <sup>1/2</sup> /W
Microphonic Voltage <sup>1</sup>	typ. 4000	$\mu\text{V}/\text{g}$
Filling Gas	Kr	
Filters	It is recommended to use filters with a CWL of 4.3 $\mu\text{m}$ or 5 $\mu\text{m}$ . Customized filters on request. For more information please see document "infrared filters".	
Operation Voltage VDD+	$\pm 2.2 \dots \pm 8$	VDC
Operation Current	max. 0.07	mA
Feedback Resistor	10	GOhm
Feedback Capacitor	200 $\pm$ 50	fF
Operation Temperature	-25 ... +125	°C
Mass	~ 1	g
Housing	T039 (modified)	

<sup>1</sup> at T<sub>amb</sub>=25 °C, 10 Hz, band width 1 Hz

<sup>2</sup> Blackbody T=500 K; E=38 W/m<sup>2</sup>

<sup>3</sup> on air without windows

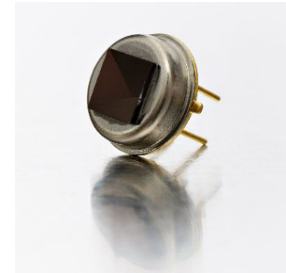

### Equivalent Circuit

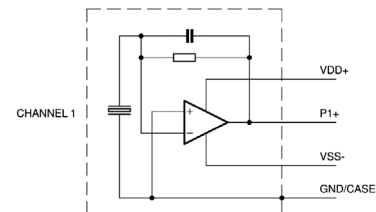

### Pin Assignment

Bottom View

- Pin 1 VSS-
- Pin 2 VDD+
- Pin 3 Output P1+
- Pin 4 GND

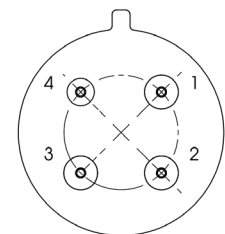

# Pyroelectric Low Noise Flame Detector PS1x3C2-A-D3.7



## Frequency Response

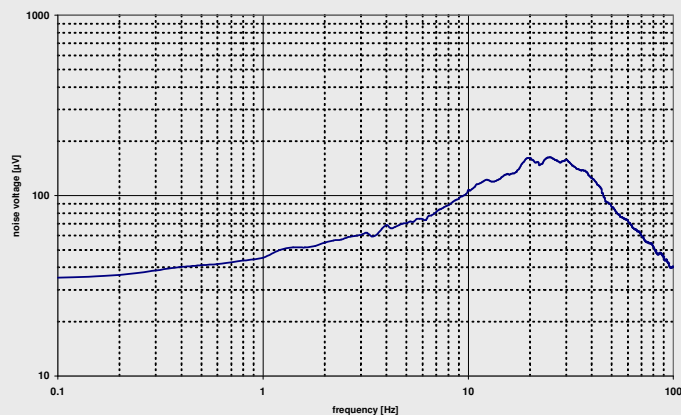
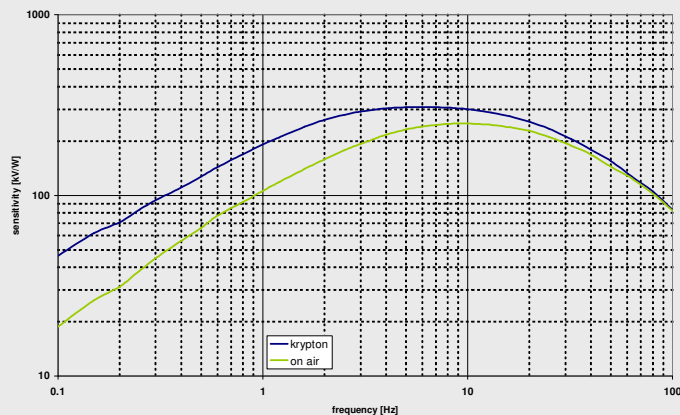

## Housing

Bottom View

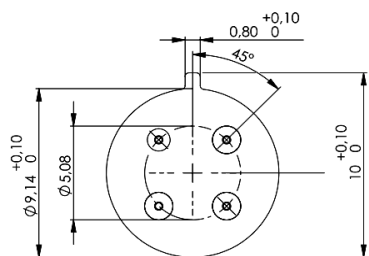

Side View

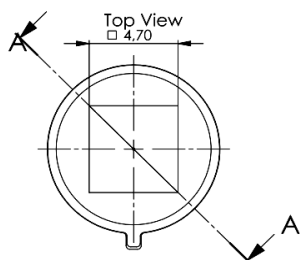
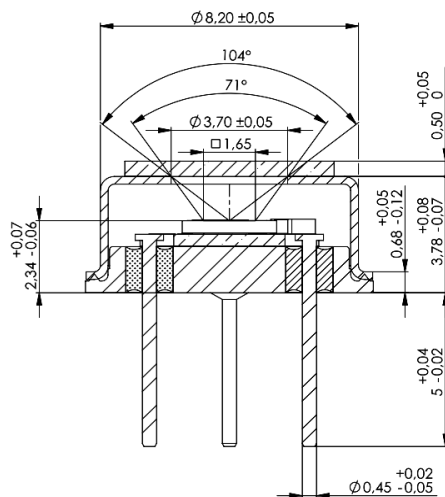

## Ordering Information

PS1x3C2-A-S1.5-Filling Gas (GG)-Filter (H)

e.g. PS1x3C2-A-S1.5-Kr-E1

## Optional parts

IR-Source JSIR 350 - Fast IR emitter based on thin film technology  
Art.-Nr. 6353.01-3.01

Evaluation Kit - For independent evaluation of emitters and detectors  
Art.-Nr. 7206.01-A.00